



Haskel

MILTON ROY



HIGH-PRESSURE VALVES AND SYSTEM COMPONENTS



OUR PRODUCTS ARE BACKED BY OUTSTANDING TECHNICAL SUPPORT, AN
EXCELLENT REPUTATION FOR RELIABILITY AND WORLDWIDE DISTRIBUTION



TABLE OF CONTENTS



Haskel International, Inc.
Burbank, California, U.S.A.



Haskel Energy Systems, Ltd.
Sunderland, England, U.K.

Haskel International, Inc. has almost 50 years of hydraulic and pneumatic engineering experience in the design and manufacture of air driven gas boosters, air amplifiers and liquid pumps. Located in Burbank, California, U.S.A., with an additional manufacturing plant in Sunderland, United Kingdom, the company is supported by a worldwide network of offices and distributors.

Haskel products now offer the most complete range in this industry, whether measured by ultimate pressure flow or output horsepower capability; or by the variety of media with which they are compatible. The high-pressure valves and system components described in this catalog have been designed to assist in the controlled use of pressure and flow-generating equipment manufactured by Haskel, as well as others.

Continuous investment in the most modern machinery and technology ensures that Haskel will remain the leader in this field.

	Page
Stainless Steel Check Valves	3
Air Pilot Switches	4 - 5
Air Pilot Switches — Selection Charts	6 - 7
Air Operated Directional Control and Release Valves	8
Air Piloted Valves — Typical Applications	9
Air Piloted Valves — Selection Charts	10 - 11
Regulating Relief Valves	12 - 13
Hydraulic Accumulators and Gas Receivers	14
Filters	15
Plenum Chambers	15
6000 PSI Gas Storage Cylinder	15

STAINLESS STEEL CHECK VALVES

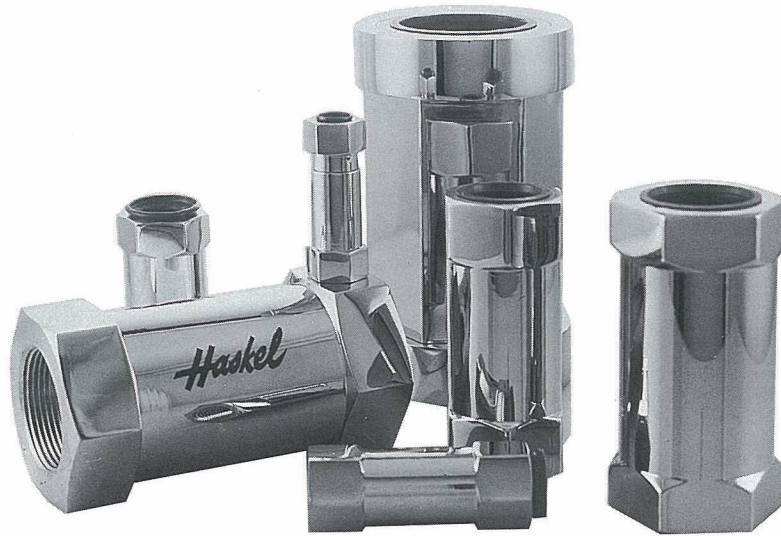

Combining the best features of durability and positive sealing, these unique valves are constructed throughout of 316 Series Stainless Steel for the high corrosion resistance essential in the chemical, processing and power generating industries.

PTFE seat seal for positive bubble-tight sealing (with gas) from cryogenic to 375° F (190°C) temperatures. Seals also available for radioactive environments, or up to 500°F steam. Can be furnished without soft seat for higher temperature steam service.

Sizes 1/4" through 1" use a ball, and for reduced inertia, the larger sizes (1-1/4", 1-1/2" and 2") use a poppet. Cracking pressure is 1-4 psi.

Larger valves can be furnished for flange mounting to customer specifications on special quantity orders. Consult factory.

Semi-soft means the check ball or poppet initially seats on the PTFE, but after the PTFE deflects a slight amount, the ball or poppet comes to rest against the metal seat so the PTFE does not have to absorb the full load of the high pressure.

Internal passages have flow capacity equal to or greater than double extra heavy pipe of the same size that would be required to carry the rated pressure (see CV factor in chart below).

Typical of good Haskel design is the removal of springs from the flow path. The larger spring is outside the flow and simply provides a preload for the disk. The smaller spring, inside the cage, actuates the ball or poppet but the flow, which is routed through the cage windows, misses the spring entirely. This is why the valves will stand extremely high shock loads and have been tested at rapid high shock up to 2 million cycles without failure.

MODEL NUMBER	NPT-SIZE (Other ports optional at extra cost)	DIMENSIONS		MINIMUM ORIFICE	CV	MAX. WORKING PRESSURE @ 375°F MAX.	
		A	B			HYDRAULIC	GAS
28201	1/4"	2-1/2"	13/16"	.156"	.44	15,000 psi	10,000 psi
56790	3/8"	2-7/8"	1"	.250"	1.10	15,000 psi	10,000 psi
28303	1/2"	3-1/8"	1-1/8"	.344"	2.10	15,000 psi	10,000 psi
28624	3/4"	3-1/4"	1-3/8"	.486"	4.20	15,000 psi	10,000 psi
28400	1"	4-1/4"	1-3/4"	.540"	5.20	12,000 psi	8000 psi
54080	1-1/4"	4-5/8"	2-1/4"	.900"	14.50	7500 psi	6000 psi
53520	1-1/2"	5-1/2"	2-3/4"	1.045"	19.60	6000 psi	5000 psi

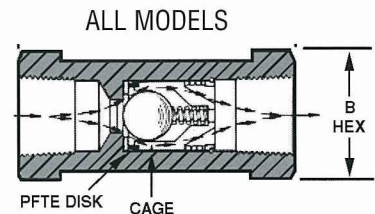

For oxygen service, add -10 after model no. (e.g., 28303-10) 5000 psi maximum.

AIR PILOT SWITCHES



STYLE A

Externally Adjusted

- 19 models
- Sensing pressures to 25,000 psi
- Air valve* 3-way, 2-way normally open or closed



STYLE B

Remote Air Adjusted "Remoteset"™

- 4 models
- Sensing pressures to 60,000 psi
- Air valve* 3-way normally closed, 2-way normally closed, normally open

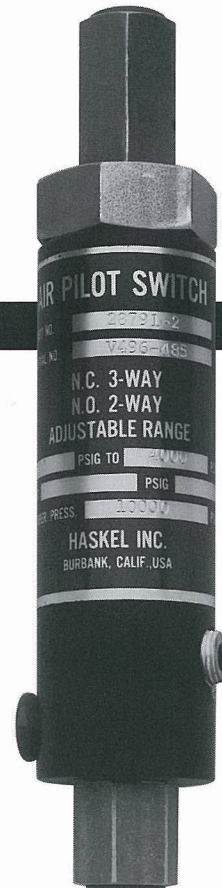

STYLE C

Internally Adjusted

- 34 models
- Sensing pressures to 60,000 psi
- Air valve* 3-way normally closed, 2-way normally closed, normally open

Description

An Air Pilot Switch is a pressure switch. These units produce a pneumatic signal up to 150 psi at any sensing pressure within their adjustment range. The signal valve may be piped normally open, normally closed*, 3-way or 2-way depending on model.

All models use a 2-position poppet-type air signal valve which is shifted from its normal position by a rod from the sensing end which first must overcome an adjustable force spring (styles A and C) or air-regulated dome loader (style B).

* Air valve terminology is the reverse of an electrical switch. Closed means no flow; open means flow.

Applications

- Direct automatic start/stop control of any Haskel pump, gas booster, air amplifier or indirectly to the drive of any pump or compressor sensing either output or suction (schematics 1 & 2)
- Valve actuators (schematic 5)
- Pneumatic alarm signals
- Replace an explosion-proof pressure switch in hazardous applications (schematic 6)

Application Schematics

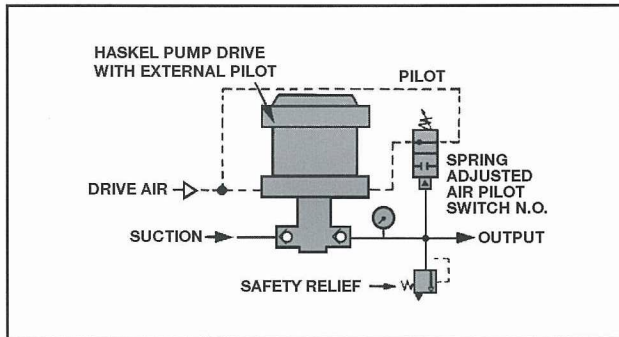

1. Maximum output pressure control, spring adjusted

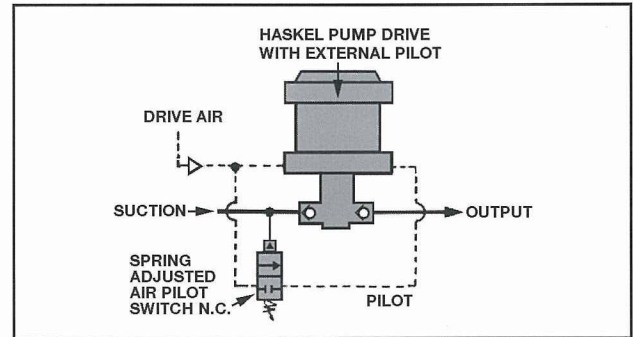

2. Minimum suction pressure control, spring adjusted

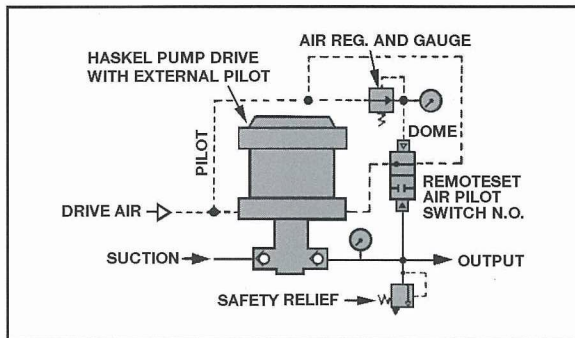

3. Maximum output pressure control remote, air adjusted

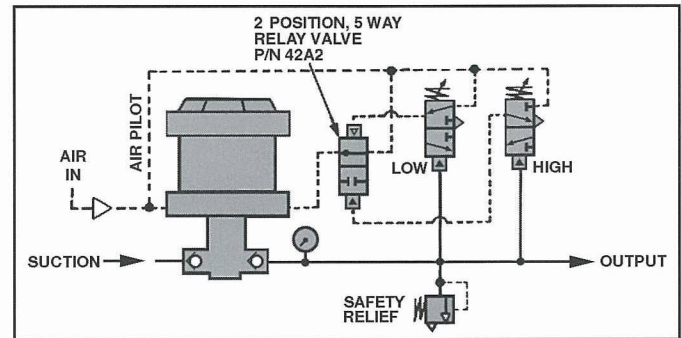

4. Wide deadband control with two adjustable air pilot switches plus a two-position valve

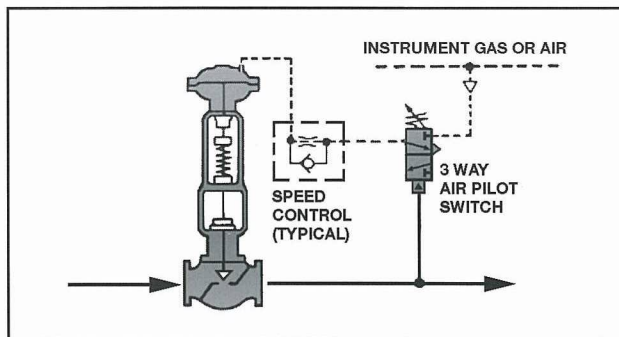

5. Process valve control

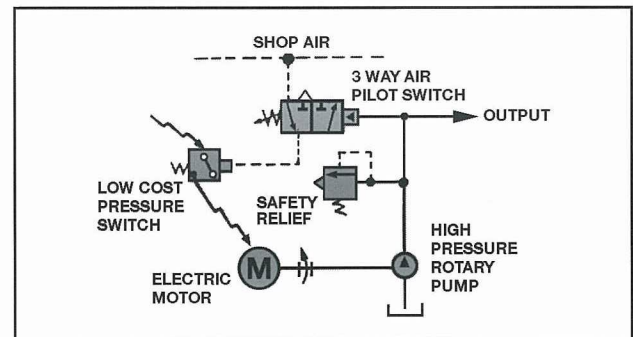

6. Electric pump/motor control where standard pressure switches are unsuitable at pump output

A word about "deadband"

Users often try to compare the on-off action of the air signal with the action of an electrical switch. They are not really comparable. The air switch has no "snap-over" mechanism required with an electric switch to prevent arcing. Therefore, "on" or "off" before or after a dead tight seal condition can be quite subjective. In other words, if the air pilot switch is turning on a device that not only requires a miniscule leak to start, it will start much sooner than some other larger device that may need a flow of air to start.

Therefore, it is not possible to publish precise deadband data such as that available for most electric pressure switches.

Style B Remoteset units have the lowest and most consistent deadband (5% - 10% of set pressure) because there is no heavy coil spring to compress.

Styles A and C may vary from 5% to as high as 40% depending on model and the application details.

In some applications a wider than normal deadband is needed. Schematic 4 illustrates how to provide this with two air pilot switches and a simple 2-position air valve.

AIR PILOT SWITCHES — SELECTION CHARTS



STYLE	MODEL NO.		MAXIMUM SENSING PRESSURE (PSI)	AIR VALVE	ADJUSTABLE RANGE PSI FACTORY SETTING AT NO CHARGE (Specify if Increasing or Decreasing)		APPROXIMATE DIMENSIONS (inches)		PORTS	
	SERVICE SENSING PORT				NORMALLY OPEN	NORMALLY CLOSED	LENGTH	OUTSIDE DIA.	AIR (2)	SENSING (3)
	LIQUID OR GAS	OXYGEN GAS								
A	51940-1	-11	10,000 Standard 5000 Oxygen	(1) 3-Way. May be piped N.C. or N.O. or 2-Way N.C. or N.O.	2000 - 10,000	3500 - 10,000	8	2	1/8" NPT	1/4" NPT
	51940-2	-12			700 - 4400	1200 - 4800				
	51940-3	-13			200 - 950	500 - 1300				
	52160-1	N/A	25,000		6000 - 11,000	7000 - 12,000	8-5/8			1/4" Super-pressure
	52160-2				8000 - 25,000	10,000 - 25,000				
	52160-3				3000 - 8500	4000 - 9500				
52180-1	-11	10,000 Standard 5000 Oxygen	60 - 240	150 - 300	7-5/8	1/4" NPT				

B	MODEL NO.	SERVICE SENSING PORT	MAXIMUM SENSING PRESSURE (PSI)	AIR VALVE	ADJUSTABLE RANGE PSI FACTORY SETTING AT NO CHARGE (Specify if Increasing or Decreasing)	APPROXIMATE DIMENSIONS (inches)	PORTS	RATIO	
								LENGTH	OUTSIDE DIA.
	55792	N/A	25,000	3-Way. May be piped N.C. or N.O. or 2-Way N.C. or N.O.	4500 - 23,400 with 20-100 Dome Load. Nominal Ratio 245:1	8-3/4	1/8" NPT	1/4" Super-pressure	245:1
	55796	N/A	600		135 - 530 with 20-100 Dome Load. Nominal Ratio 6:1	7-1/2		1/4" NPT	6:1

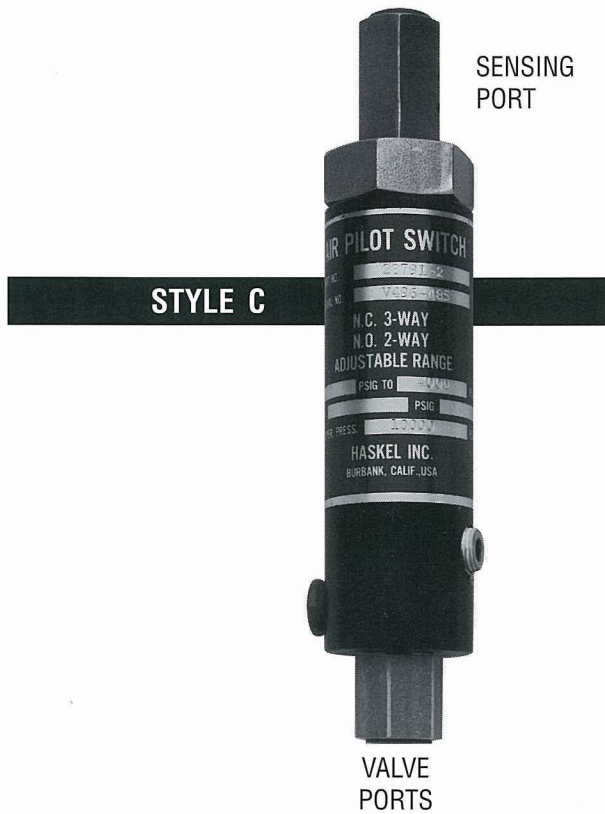

Notes:

- (1) SAFETY: When using N.O. models to limit pump output pressure, also include a backup relief valve. (Ref. schematics 1, 3, 4, 6, page 5.)
- (2) AIR VALVE: Materials are Aluminum, Stainless Steel, Bronze, and Buna suitable for air and most gases. Modification available for sour natural gas to meet NACE SPEC. MR-01-75.
- (3) SENSING SECTIONS: Materials are Stainless Steel, PTFE, Buna (with Viton or Silicone for Oxygen) suitable for most liquids or gases. Modification available for sour natural gas and fire-resistant hydraulic fluids.

STYLE	MODEL NO.		MAXIMUM SENSING PRESSURE (PSI)	AIR VALVE	ADJUSTABLE RANGE PSI FACTORY SETTING AT NO CHARGE (Specify if Increasing or Decreasing)		APPROXIMATE DIMENSIONS (inches)		PORTS	
	SERVICE SENSING PORT				NORMALLY OPEN	NORMALLY CLOSED	LENGTH	OUTSIDE DIA.	AIR (2)	SENSING (3)
	LIQUID OR GAS	OXYGEN GAS								
C	28755-1 28755-2 28755-3 28755-8	-11 -12 -13 -18	10,000 Standard 5000 Oxygen	3-Way N.C.		1500 - 10,000 300 - 3500 150 - 700 800 - 9500	5-11/16	1-3/8	1/8" NPT (Vent not Threaded)	1/4" NPT
	28791-1 28791-2 28791-3 28791-4	-11 -12 -13 -14		(1) 2-Way N.O.	2500 - 10,000 750 - 4000 250 - 750 2000 - 8500	6-1/8	1/4" NPT Out 1/8" NPT In			
	28974-24 28974-25	N/A	25,000	3-Way N.C.		6000 - 25,000	8	2	1/8" NPT (Vent not Threaded)	1/4" Super-pressure
				2-Way N.C.						
	28974-59 28974-60	N/A	60,000 (Intermittent)	3-Way N.C.		20,000 - 60,000	8	2	1/8" NPT (Vent not Threaded)	1/4" Super-pressure
			2-Way N.C.							
	29074-25 29074-60	N/A	25,000 60,000 (Intermittent)	(1) 2-Way N.O.	6000 - 25,000 20,000 - 60,000		8		1/4" NPT Out 1/8" NPT In	
	55230-1 55230-3	-11 -13	600	3-Way N.C.		12 - 37 17 - 200	6-1/2	2-1/8	1/8" NPT (Vent not Threaded)	1/4" NPT
	55416-1 55416-2	-11 -12		Pipe either (1) 3-Way N.C. or 2-Way N.O.	13 - 47 28 - 200	13 - 47 28 - 200	7		1/4" NPT N.O. 1/8" NPT Others	
	56650-1 56650-2	-11 -12	10,000 Standard 5000 Oxygen	3-Way N.C.		50 - 180 110 - 900	6-5/16	1-3/8	1/8" NPT (Vent not Threaded)	

AIR OPERATED DIRECTIONAL CONTROL AND RELEASE VALVES

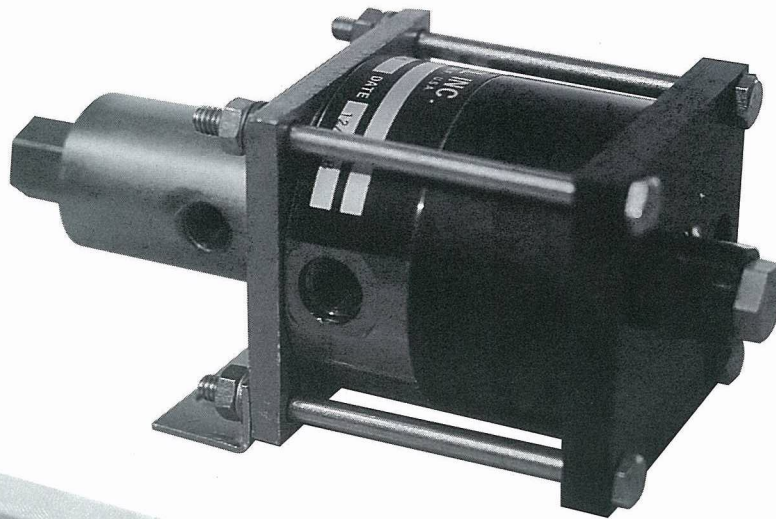

3-Way Release Valve
Model 50135



Release Valve
Model 28940-1



Release Valve
Model 53585



Release Valve
Model 54416

These directional control valves are basically a family with common characteristics and benefits.

- They are seated poppet or ball design for virtually zero leakage at high pressures with low viscosity fluids. They are not "bubble-tight" on gas.

Note: Normally open models will generally hold a tighter seal on low viscosity liquid or gas because seating force does not depend on inlet pressure.

- They are directly air-actuated for ideal system compatibility in wet or hazardous areas, or when used with air driven pumps or boosters. Yet, if electronic or electrical control is preferred, they can be actuated with any of the

wide selection of subminiature 3-way solenoid air valves available from many manufacturers.

- They employ the same basic area ratio principle used in Haskel pumps enabling high forces to be easily and directly controlled from low-pressure plant main or instrument air.
- Although not normally considered for pressure control, all of the normally open 2-way models can do double-duty in a circuit by also providing a safety relief function simply by installing a small air regulator in their pilot line (schematics next page).

AIR PILOTED VALVES — TYPICAL APPLICATIONS

50135 3-WAY NORMALLY CLOSED

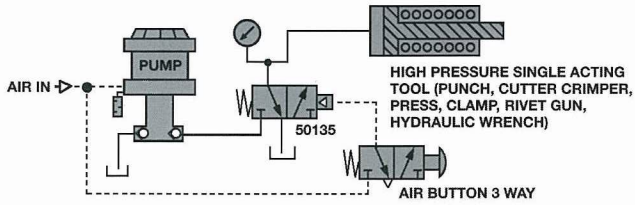

53430 3-WAY NORMALLY OPEN

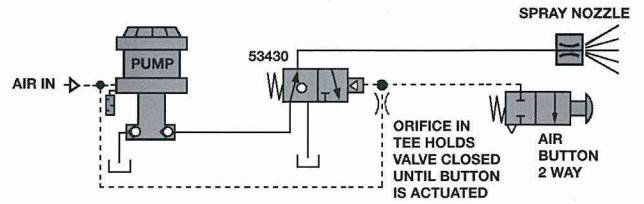

NOTES:

1. IF TOOL IS DOUBLE ACTING, ADD ANOTHER 50135 WITH AIR BUTTON IN PARALLEL.

2. IF ADDITIONAL TOOLS ARE TO BE POWERED OFF SAME PUMP, ADD VALVES IN PARALLEL WITH CHECK VALVE AT EACH INLET PORT.

28940 or 53581 2-WAY, NORMALLY CLOSED, 2-STAGE

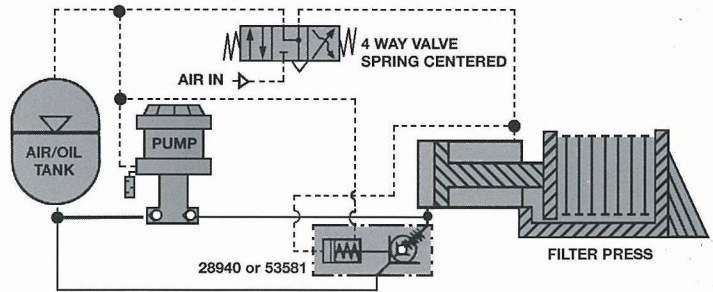

53585 2-WAY NORMALLY CLOSED

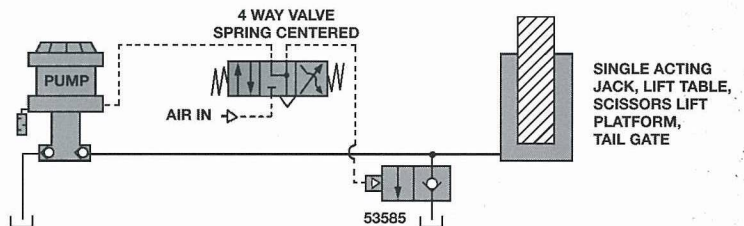

54416 or 54492 2-WAY NORMALLY OPEN

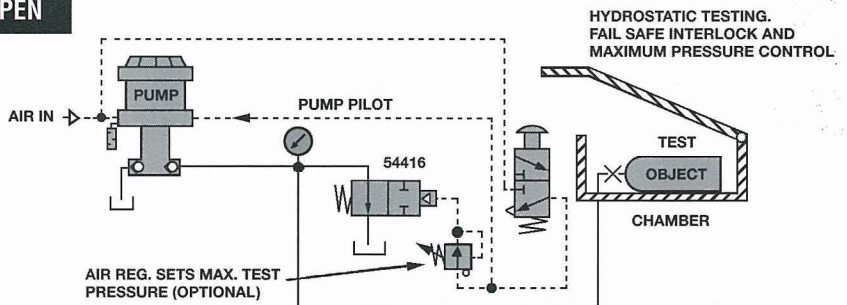

53560 2-WAY NORMALLY OPEN

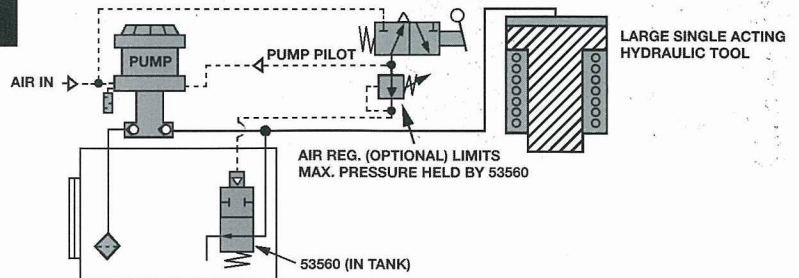

AIR PILOTED VALVES — SELECTION CHARTS

TYPE	NORMAL POSITION	SCHEMATIC WITH APPROXIMATE WEIGHT AND SIZE	MODEL NUMBER	REMARKS	NOMINAL AREA RATIO FOR ACTUATION	MAXIMUM INLET WITH 100 PSIG AIR PILOT	CV (MIN.)	PORT SIZES AND MAXIMUM PRESSURES, PSI		MATERIALS (LIQUID SECTION)
								P, C or B	T or A	
3-WAY	Closed	<p>Weight: 5-3/4 lbs.</p>	50135	<ul style="list-style-type: none"> Closed crossover Dual C porting 	150:1		P to C .42	1/4" NPT 10,000	3/8" SAE Tube 3000	Plated Steel, Polyurethane, Buna N
			50135-1	<ul style="list-style-type: none"> Same as above and includes manual override 	150:1	10,000 psi	C to T .64			
	Open	<p>Weight: 1 lb.</p>	53430-4	<ul style="list-style-type: none"> Open crossover Rated for plain water 	85:1	8500 psi	.3	1/4" NPT 15,000	1/4" NPT 3000	Stainless Steel, Buna N, PTFE
			53430-5		50:1	5000 psi	.6			
			53430-6		40:1	4000 psi	.8			
			53430-7		150:1	12,000 psi	.1			

AIR PILOT PORTS: 150 PSI MAXIMUM ALL MODELS	SIZE	MODELS
	1/8" NPT	54416, 53430, 53585, 28940, 53581 (C)
	1/4" NPT	50135, 53560, 53581 (D)

TYPE	NORMAL POSITION	SCHEMATIC WITH APPROXIMATE WEIGHT AND SIZE	MODEL NUMBER	REMARKS	NOMINAL AREA RATIO FOR ACTUATION	MAXIMUM INLET WITH 100 PSIG AIR PILOT	CV (MIN.)	PORT SIZES AND MAXIMUM PRESSURES, PSI		MATERIALS (LIQUID SECTION)		
								P, C or B	T or A			
2-WAY	Closed	<p>RELEASE VALVES MODELS 28940 and 28940-1 Weight: 2-3/4 lbs. MODELS 53581 - Weight: 5 lbs.</p>	28940	<ul style="list-style-type: none"> 2-stage decompression and release Rated for plain water 	250:1 (1st stage) 9:1 (2nd stage)	15,000 psi	1st stage - .1 2nd stage - 1.50	1/2" NPT 15,000	1/2" NPT 10,000	Stainless Steel, Buna N, PTFE		
		28940-1	<ul style="list-style-type: none"> 2-stage decompression and release 	150:1 (1st stage) 12:1 (2nd stage)	6000 psi	1st stage - .4 2nd stage - 5.5	1" NPT 6000	3/4" NPT 500	Plated Steel, Buna N, PTFE			
		53581										
			<p>RELEASE VALVE MODEL 53585 Weight: 1 lb.</p>	53585	<ul style="list-style-type: none"> Single-stage release Rated for plain water 	110:1	10,000 psi	.1	1/4" NPT 10,000			
	Open		<p>RELEASE VALVE MODEL 54416 Weight: 1 lb.</p>	54416 54492-1	<ul style="list-style-type: none"> Rated for plain water 54492 is needle type allowing flow in either direction 	55:1	5000 psi	.6	1/4" NPT 15,000	1/4" NPT 3000	Stainless Steel, Aluminum, Buna N	
			54416-1 54492	120:1		11,000 psi	.25					
			54416-2 54492-2	160:1		15,000 psi	.15					
			54416-3	90:1		7800 psi	.32					
			54416-4	300:1		25,000 psi	.08	1/4" super-pressure 25,000				
			<p>RELEASE VALVE MODEL 57175 - Weight: 5 lbs.</p>	57175-30		<ul style="list-style-type: none"> Rated for plain water Needle type allows flow in either direction 	600:1	30,000 psi				.15
		57175-60	1200:1	60,000 psi		.09	1/4" super-pressure 60,000					
	<p>RELEASE VALVE MODEL 53560 - Weight: 2 lbs.</p>	53560-12	<ul style="list-style-type: none"> Designed for mounting inside tank 	25:1	2500 psi	5.5	1/2" NPT 3000	5/8" Dia. Vent Hole ATM	Plated Steel, Aluminum, Buna N			
	53560-150	160:1		15,000 psi	.85	1/4" NPT 15,000						

REGULATING RELIEF VALVES

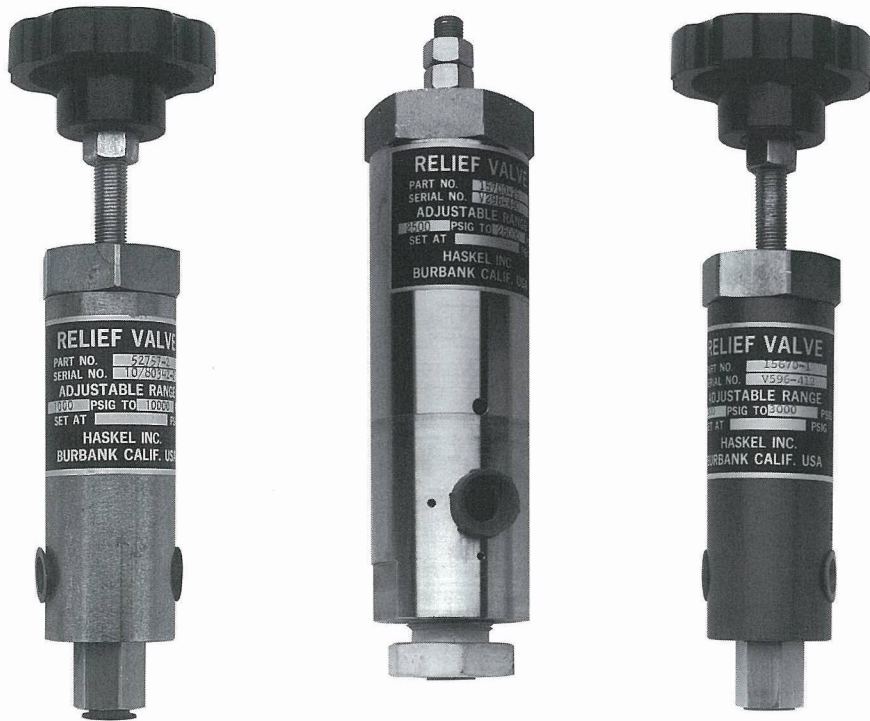

These valves were originally developed in response to the need for accurate regulation of high pressure at low flow without the "chatter" often encountered with valves of this size. They are differential area poppet design with a high ratio between seal and seat area for smooth control, repeatability and low deadband between crack and reseal pressure.

bubble tight, they do an excellent job holding high-pressure gas due to their precision poppet and hardened stainless steel seat with heavy silver plating.

Flow capacity is ultimately determined by the seat orifice and its CV rating as listed in the chart of models. The following curves show the typical effect of the .070" seat orifice as flow increases from the point at which the valve is set to relieve.

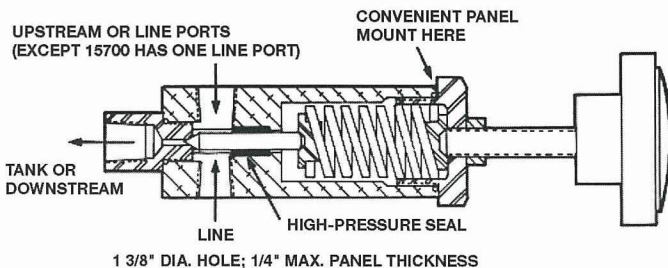

The configuration also makes the control settings virtually unaffected by downstream outlet pressure. This enables the valves to be also used for back pressure control (upstream pressure controller) or as a sequence (priority pressure) valve.

Materials of construction options seen in the chart of model numbers provide selections for most liquids including plain water plus most industrial gases including pure oxygen. Note that the nylon insert seat models are recommended for all gas applications below 10,000 psi. The 15700 series valves for service up to 60,000 psi are normally used as safety valves at these pressures. Although not rated as

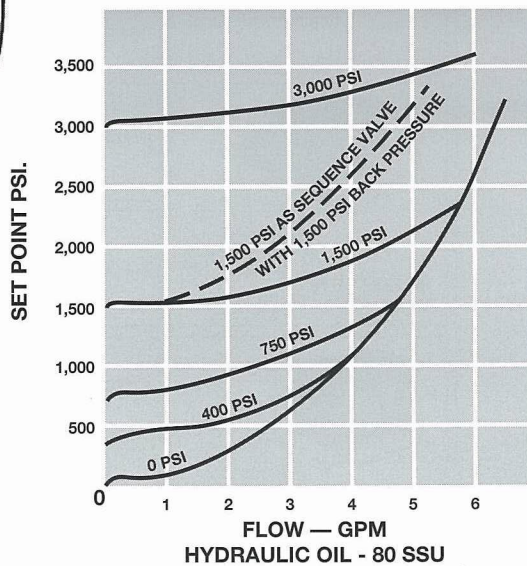

MODEL NUMBER	SERVICE	PRESSURE RANGE	PORTS		MATERIAL			ORIFICE DATA	
			PRESSURE	OUTLET	BODY	SEAT	SEAL	DIA.	CV
15570-1 15570-2 15570-3	Liquid Liquid Liquid	300 - 3000 psi 600 - 6000 psi 1000 - 10,000 psi	1/4" NPT 1/4" NPT 1/4" NPT	1/4" NPT 1/4" NPT 1/4" NPT	Alum. Alum. Steel	St. Steel St. Steel St. Steel	Buna-N Buna-N Buna-N	.070" .070" .070"	.12 .12 .12
15670-1 15670-2	Gas or Liq. Gas or Liq.	300 - 3000 psi 600 - 6000 psi	1/4" NPT 1/4" NPT	1/4" NPT 1/4" NPT	Alum. Alum.	Nylon Nylon	Buna-N Buna-N	.070" .070"	.12 .12
15900-1 15900-2	Gas or Liq. Gas or Liq.	30 - 300 psi 75 - 750 psi	1/4" NPT 1/4" NPT	1/4" NPT 1/4" NPT	Alum. Alum.	Nylon Nylon	Buna-N Buna-N	.156" .156"	.58 .58
15901-1 15901-2	Liquid Liquid	30 - 300 psi 75 - 750 psi	1/4" NPT 1/4" NPT	1/4" NPT 1/4" NPT	Alum. Alum.	St. Steel St. Steel	Buna-N Buna-N	.296" .296"	2.09 2.09
15960-1 15960-2	Liquid Liquid	300 - 3000 psi 150 - 1500 psi	3/8" NPT 3/8" NPT	3/8" NPT 3/8" NPT	Alum. Alum.	St. Steel St. Steel	Buna-N Buna-N	.187" .187"	.83 .83
15700-25 15700-26 15700-60	Liq./Gas ** Liq./Gas ** Liq./Gas **	2500 - 25,000 psi 2500 - 25,000 psi 10,000 - 60,000 psi	1/4" S.P.* 1/4" S.P.* 1/4" S.P.*	1/4" NPT 1/4" S.P.* 1/4" NPT	St. Steel St. Steel St. Steel	St. Steel St. Steel St. Steel	Buna-N Buna-N Buna-N	.070" .070" .070"	.12 .12 .12
27741-1 27741-2 27741-3 27741-4 27741-11 27741-12	Liquid Liquid Gas or Liq. Gas or Liq. Oxygen Oxygen	300 - 3000 psi 1000 - 10,000 psi 300 - 3000 psi 1000 - 10,000 psi 300 - 3000 psi 500 - 5000 psi	1/4" NPT 1/4" NPT 1/4" NPT 1/4" NPT 1/4" NPT 1/4" NPT	1/4" NPT 1/4" NPT 1/4" NPT 1/4" NPT 1/4" NPT 1/4" NPT	St. Steel St. Steel St. Steel St. Steel St. Steel St. Steel	St. Steel St. Steel Nylon Nylon Nylon Nylon	Viton/PTFE Viton/PTFE EPR/PTFE EPR/PTFE Viton/PTFE Viton/PTFE	.070" .070" .070" .070" .070" .070"	.12 .12 .12 .12 .12 .12

* Superpressure ** Not bubble-tight on gas service

MODELS 15570, 15670, 15900, 15901 & 27741

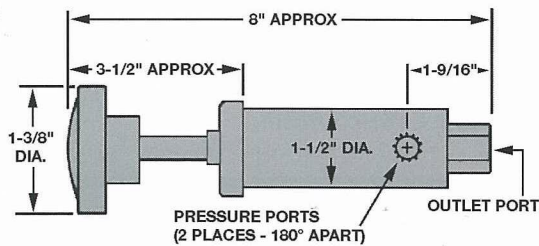

MODEL 15960

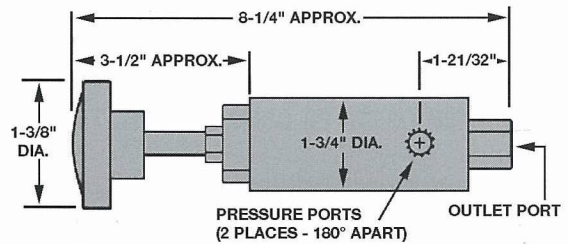

TO ORDER WITH ADJUSTING SCREW (NO KNOB)

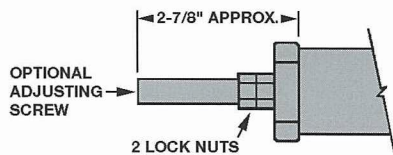

FOR MODELS

15570-1, 2, 3
15670-2, 2
27741-1, 2, 3, 4, 11, 12

ORDER

27560-XX
28440-XX
28580-XX

MODEL 15700

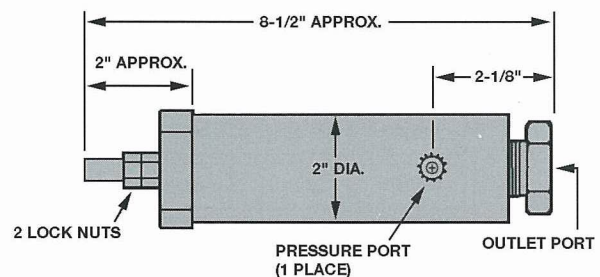

HYDRAULIC ACCUMULATORS AND GAS RECEIVERS



HYDRAULIC ACCUMULATORS

Hydraulic Accumulators for use with Haskel high-pressure hydraulic pumps. Will store large amounts of energy. Suitable for mineral base oils and DC-200 silicon oil. Suitable seals can be furnished on special order for phosphate-ester base liquids.

Each accumulator is proof tested to twice its maximum working pressure. To increase oil storage capacity, Haskel gas receivers can be connected to gas end of accumulators. Always precharge with nitrogen (not air).

Materials: Heat treated chromoly steel; barrel painted on outside, unplated inside; ends nickel plated; pistons are high-strength aluminum; seals are Buna-N with PTFE backups.

GAS RECEIVERS

Gas Receivers are designed for use with Haskel gas booster compressors and as backup gas storage for Haskel accumulators. Suitable for non-corrosive gases (helium, argon, nitrogen, etc.). Oxygen service on special order only, 5000 psi maximum. Not rated for hydrogen.

Each receiver is proof tested hydrostatically to twice its working pressure and tested for gas leakage at maximum working pressure. (This proof test exceeds both ASME and D.O.T.-3AA requirements.)

Since high-pressure gas storage vessels are critical and particularly susceptible to inside flaws, each barrel is carefully honed inside to remove all inclusions and flaws after magnetic inspection.

Materials: Heat treated chromoly steel; nickel plated inside and outside. Seals are Buna-N with PTFE backups.

NOTE: SINCE THESE ACCUMULATORS AND RECEIVERS ARE LESS THAN 6" O.D., ARE NOT WELDED AND DO NOT EXCEED 1/2 CU. FT. DISPLACEMENT, THEY DO NOT REQUIRE ASME CERTIFICATION.

MAXIMUM WORKING PRESSURE (PSI)	ACCUMULATORS			RECEIVERS			OUTSIDE DIAMETER	LENGTH	SUPER-PRESSURE PORT SIZE*
	MODEL NUMBER	OIL VOLUME	APPROX. WEIGHT	MODEL NUMBER	ACTUAL DISPLACEMENT	APPROX. WEIGHT			
10,000	15801-1	366 cu. in.	163 lbs.	15542-1	443 cu. in.	154 lbs.	5-3/4"	39"	9/16"
	15801-2	820 cu. in.	270 lbs.	15542-2	897 cu. in.	261 lbs.		71"	
	15806-1	185 cu. in.	57 lbs.	15706-1	210 cu. in.	54 lbs.	3-3/4"	36"	3/8"
	15811-1	16 cu. in.	11 lbs.	15711-1	21 cu. in.	10 lbs.	2-3/8"	13-1/8"	
	15811-2	31 cu. in.	14 lbs.	15711-2	36 cu. in.	13 lbs.		19-7/8"	
	15711-3	66 cu. in.	22 lbs.	15711-3	66 cu. in.	22 lbs.		32-1/4"	
20,000	15802-2	841 cu. in.	449 lbs.	15545-2	890 cu. in.	444 lbs.	5-3/4"	94"	9/16"
	15807-1	122 cu. in.	82 lbs.	15707-1	134 cu. in.	81 lbs.	3-3/4"	39"	3/8"
	15812-1	16 cu. in.	13 lbs.	15712-1	20 cu. in.	13 lbs.	2-3/8"	14-3/4"	1/4"
	15812-2	31 cu. in.	20 lbs.	15712-2	35 cu. in.	19 lbs.		23-1/4"	
	15712-3	65 cu. in.	32 lbs.	15712-3	65 cu. in.	32 lbs.		40-1/4"	

* Available with pipe thread – special order

Particle filters — 5 micron nominal

These units are designed as the final protection with gas boosters handling purified gases, or liquid pumps handling pre-filtered clean liquids. The elements do not have sufficient area to be practical for more than occasional particle migration due to pump wear or improperly cleaned piping or containers. They have proven to be good insurance particularly on high-pressure gas systems.

- Filtration: 5 micron nominal
- All stainless steel barstock
- Pressure drop:
 - 25 psi @ 3 gpm MIL-H-5606 oil across paper element.
 - 10 psi @ 100 scfm gas at 3000 psi across stainless steel element

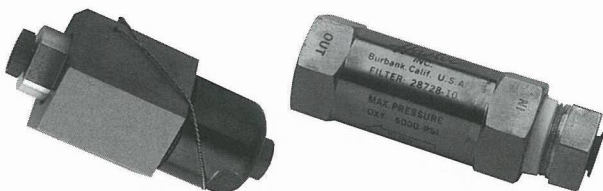

28728 SERIES

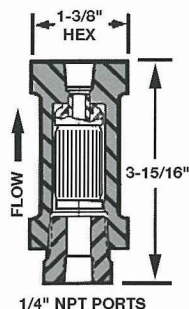

28700 SERIES

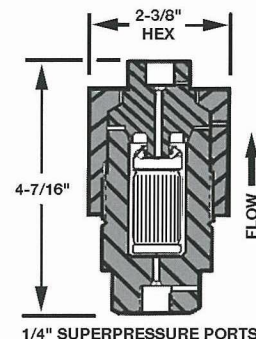

MODEL NUMBER	SERVICE	MAXIMUM RATED OPERATING PRESSURE	ELEMENT
28700-1	Gas/Liquid	30,000 psi	St. Steel
28728-1	Gas	6000 psi	St. Steel
	Liquid	8000 psi	
28728-2	Liquid	8000 psi	Paper
28728-10	Oxygen	5000 psi	St. Steel

PLENUM CHAMBERS



SMALL TUBULAR ALL AISI 300 SERIES STAINLESS STEEL
Used in air amplifier and gas booster assemblies to dampen pulsation between stages.

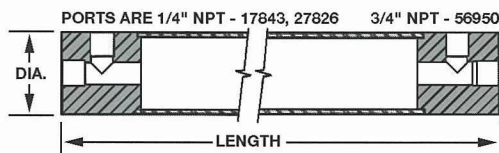

MODEL NUMBER	VOLUME	WORKING PRESSURE	PROOF PRESSURE	LENGTH	DIAMETER	WEIGHT
17843	25 cu. in.	1400 psi	2800 psi	20"	1-1/2"	4 lbs.
27826	20 cu. in.	5000 psi	10,000 psi	23"	1-1/2"	7 lbs.
56950	100 cu. in.	1250 psi	2500 psi	24"	2-3/4"	12 lbs.

6000 PSI GAS STORAGE CYLINDER

- Manufactured and certified to DOT-E-9909-6000 specifications for 6000 psi gas at 70°F
- Actual volume: 2640 ACI (1.53 ACF).
- Capacities @ 6000 psi:
 - Air-509 SCF. N₂-494 SCF
 - AR-581 SCF. He-525 SCF
- One-piece forged and heat-treated alloy steel construction
- Primed and orange-yellow painted exterior with stainless steel port adapter
- Nominal dimensions: 9.28" O.D. x 52" high



MODEL	PORT	WEIGHT
13687-9-20SS	3/8" MS16142-6	189 lbs.
13687-9-80SS	3/8" Superpressure	
13687-9	3/4" NPT	



Haskel International

100 East Graham Place
Burbank, California 91502 • USA
Telephone: (818) 843-4000

Fax: (818) 556-2549 or (818) 841-4291
www.haskel.com



Haskel United Kingdom

North Hylton Road
Sunderland SR5 3JD • England • UK
Tel: 44-191-549-1212 • Fax: 44-191-549-0911

Haskel Asia

23 Tagore Lane #03-06
Tagore 23 Warehouse Complex
Singapore 787601
Tel: 65-6455-7559 • Fax: 65-6455-2841
www.haskel.com.sg

Haskel Australia

P.O. Box 267
Salisbury, Qld. 4107, Australia
Tel: 61-7-3277-9118 • Fax: 61-7-3277-6129
www.haskel.com.au

Haskel Germany

D-46485 Wesel
Fritz-Haber Strasse • Germany
Tel: 49-281-98-48-00 • Fax: 49-281-98-48-020
www.haskel.com.de

Haskel France

4 rue du haut de la Cruppe
F-59650 Villeneuve d'Ascq • France
Tel: 33-320-04 66 00 • Fax: 33-320-33 31 95
www.haskel.fr

Haskel Spain

Paseo Urbarburu 81 • Edif.5 • 1ª Planta
Locales 1 y 2 • Pol. 27 Martutene
20115 Astigarraga • Gipuzkoa • Spain
Tel: 34-943-47 45 66 • Fax: 34-943-45 11 86
www.haskel-es.com

Haskel Aberdeen

Unit 14, Airways Industrial Estate,
Pitmedden Road
Dyce, Aberdeen AB21 ODT • Scotland
Tel: 01224-771784 • Fax: 01224-723642

Haskel Italy

via Carabelli 28
21041 Albizzate • Varese • Italy
Tel: 39-331-987596 • Fax: 39-331-987597
www.haskel.it

For further information on
Haskel products, visit our web-
site at: www.haskel.com