

EQUIPMENT FOR SOUR GAS SERVICE

BuTech Sour Gas Valves, Fittings and Tubing are designed to withstand H₂S Sour Oil and Gas high pressure environments. BuTech components are designed for shutoff service, gauge mounting, or installation of tubing systems for recording of pressures at remote locations. Other applications include research and testing laboratories engaged in the use of hydrogen sulfide.

Available in a variety of body styles, the SOG valves are designed for operation at pressures ranging to 30,000 PSI at 100°F (2070 bar at 38°C).

BuTech wellhead components are Compliant to International Standard NACE MR0175 / ISO 15156 and standards issued by the American Petroleum Institute.

Manufacturing and assembly processes are subject to rigid quality control procedures including non-destructive testing at appropriate stages to ensure specification compliance on component products. Records are maintained to verify compliance in material procurement, heat treating, and testing. Certification of testing and specification compliance is available upon request.

Needle Valve Features:

- 316 annealed stainless steel body
- Two-piece Alloy 725 Stem in two styles:
 - Vee style for on-off service
 - Regulating style for on-off and flow control service
- Glass-filled PTFE and Nylatron packings
- Integral through holes for bracket mounting. A panel-mounting option is also available (see page SOG-2)
- Wide range of options allow customizing of valve
- Positive gland locking device

Tube Sizes: 1/4" through 9/16"
Pressures to 30,000 PSI (2070 bar)
Type: H/P Cone-and-Thread

Tube O.D.	Connection	Orifice	Cv*	MAWP+
1/4"	1/4" H/P	0.093" (2.4 mm)	0.08	30,000 PSI 2070 bar
3/8"	3/8" H/P	0.125" (3.2 mm)	0.09	30,000 PSI 2070 bar
9/16"	9/16" H/P	0.125" (3.2 mm)	0.14	30,000 PSI 2070 bar

*Cv values listed are for 2-way straight pattern valves.
 For 2-way angle pattern valves, increase Cv value by 50%.
 +Maximum allowable working pressure at 72° F (22° C)

Equipment	Page
Adapters	SOG-12
Anti-Vibration Glands	SOG-15
Bleed Valves	SOG-3
Bulkhead Couplings	SOG-10
Caps	SOG-15
Check Valves	SOG-16
Collars	SOG-15
Couplings	SOG-11
Crosses	SOG-10
Elbows	SOG-10
Filters	SOG-17
Glands	SOG-15
Needle Valves, 20,000 PSI	SOG-4
Needle Valves, 30,000 PSI	SOG-7
Nipples	SOG-14
Plugs	SOG-15
Safety Heads	SOG-18
Sub-Sea Equipment	SOG-19
Tees	SOG-10
Tubing	SOG-14
Wellhead Gauge Valves	SOG-3

Equipment for sour gas service supplied without collars and glands unless otherwise specified

All dimensions are for reference only and are subject to change.
 Dimensions in parentheses are millimeters (mm)

ORDERING INFORMATION & REPLACEMENT PARTS

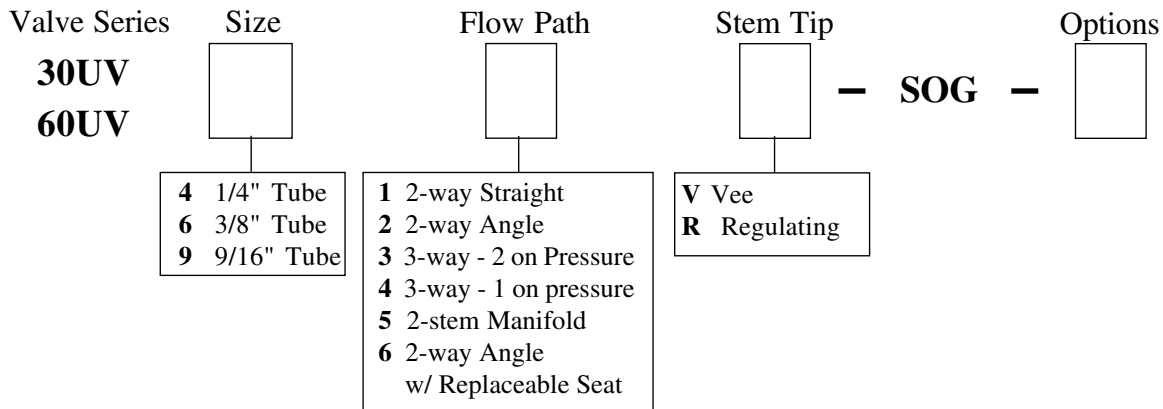

Examples:

30UV42V-SOG specifies a 2-way angle valve for 1/4" tube with a Vee stem

60UV91R-SOG-PM specifies a 2-way straight valve for 9/16" tube with regulating stem and panel-mount packing gland option

Panel Mount Option

-PM Panel-mount packing gland

Valve Model	Panel Hole Size	Max Panel Thickness	H
30UV	0.84" (21.3)	0.37" (9.4)	0.48" (12.2)
60UV	0.84" (21.3)	0.37" (9.4)	0.48" (12.2)

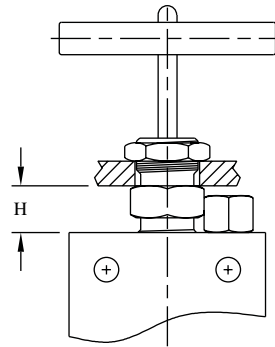

Replacement Parts

BuTech offers replacement parts in a variety of packages so you can purchase just the parts you need.

Replacement Stem Kit contains just the stem

Replacement Packing Kit contains all soft packing rings

Repair Kits contain stem, stem sleeve, stem nuts and washers, packings and packing washers (replacement seat where applicable)

Valve Series	Repair Kits		Replacement Stem	Replacement Packings	Replacement Valve Body
	All others	Replaceable Seat			
30UV4	RK-30UV4*-SOG	RK-30UV46*-SOG	30S4*-SOG	30PK4	30UV4+-SOG
30UV6	RK-30UV6*-SOG	RK-30UV66*-SOG	30S6*-SOG	30PK6	30UV6+-SOG
30UV9	RK-30UV9*-SOG	RK-30UV96*-SOG	30S9*-SOG	30PK9	30UV9+-SOG
60UV4	RK-60UV4*-SOG	RK-60UV46*-SOG	60S4*-SOG	60PK4	60UV4+-SOG
60UV6	RK-60UV6*-SOG	RK-60UV66*-SOG	60S6*-SOG	60PK6	60UV6+-SOG
60UV9	RK-60UV9*-SOG	RK-60UV96*-SOG	60S9*-SOG	60PK9	60UV9+-SOG

*Complete catalog number by adding **V** or **R** for stem type

+Complete catalog number by adding the flow path designator:

- 1 2-way straight
- 2 2-way angle
- 3 3-way, 2 connections on pressure
- 4 3-way, 1 connection on pressure
- 5 2-stem manifold
- 6 2-way angle with replaceable seat

WELLHEAD GAUGE & BLEED VALVES

BuTech Wellhead Gauge and Bleed valves are standard 316 stainless steel annealed material for SOG service and comply with NACE MR0175 / ISO 15156. Special materials available on request.

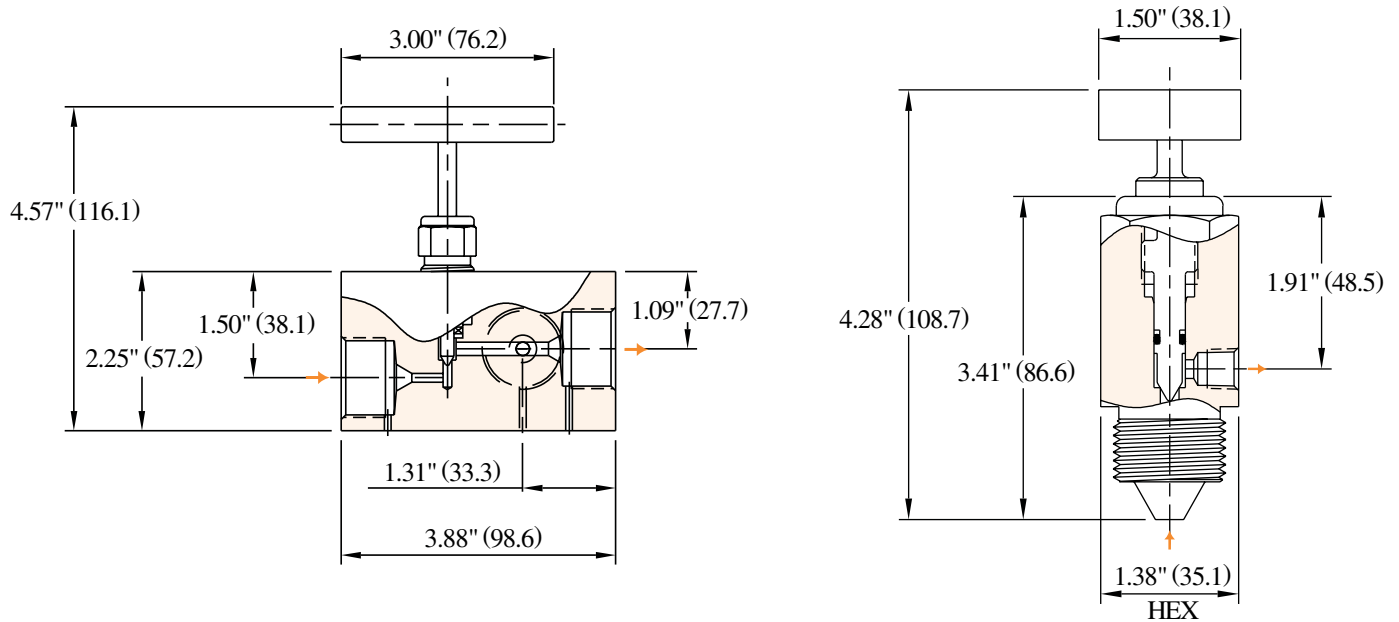

Wellhead Gauge Valve 30WGV97V-SOG

- One inlet, three outlet ports
- Ideal for sampling or instrument calibration
- Packing located below stem threads
- Metal-to-metal seat for bubble-tight shutoff
- One-piece stem
- Collars & Glands not included

Bleed Valve 30ABV9H2P-SOG

- Vent port tapped for safe plumbing
- Positive blow-out prevention on stem
- Easy T-handle operation
- Metal-to-metal seat for bubble-tight shutoff
- One-piece stem
- Compatible with standard API test and gauge connections for 20,000 PSI (1380 bar) service

Catalog Number	30WGV97V-SOG	30ABV9H2P-SOG
Service	Sour Oil & Gas	Sour Oil & Gas
Inlet Port	9/16" Female H/P	9/16" Male H/P
Discharge Port	(3) 9/16" Female H/P	1/8" Female NPT
Pressure Rating at 72°F (22°C)	20,000 PSI 1380 bar	20,000 PSI 1380 bar
Standard Material Other materials available upon request	316 annealed stainless steel	316 annealed stainless steel

All dimensions are for reference only and are subject to change.
Dimensions in parentheses are millimeters (mm)

NEEDLE VALVES FOR 20,000 PSI (1380 BAR)

**1/4" H/P TUBE
CONED AND THREADED**

2-way Straight

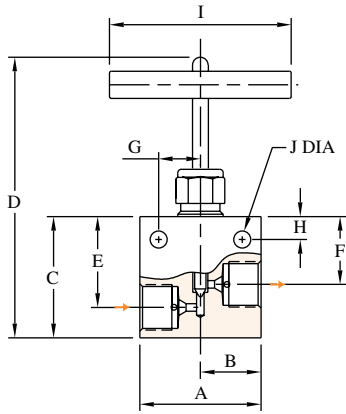

Figure 1

2-way Angle

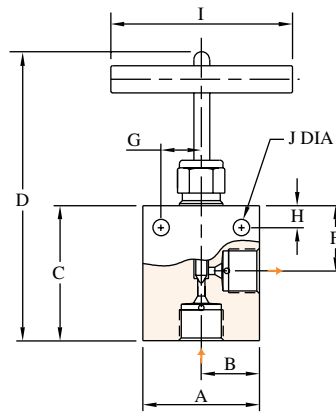

Figure 2

3-way Two on Pressure

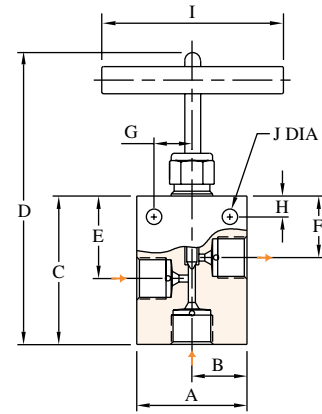

Figure 3

Catalog Number	Stem Style	A	B	C	D	E	F	G	H	I	J	K	L	Thk.	Fig
30UV41V-SOG	Vee	2.00"	1.00"	2.00"	4.77"	1.50"	1.12"	0.69"	0.38"	3.00"	0.28"	---	---	1.00"	1
30UV41R-SOG	Reg	(50.8)	(25.4)	(50.8)	(121.2)	(38.1)	(28.4)	(17.5)	(9.7)	(76.2)	(7.1)	---	---	(25.4)	
30UV42V-SOG	Vee	2.00"	1.00"	2.00"	4.77"	---	1.12"	0.69"	0.38"	3.00"	0.28"	---	---	1.00"	2
30UV42R-SOG	Reg	(50.8)	(25.4)	(50.8)	(121.2)	---	(28.4)	(17.5)	(9.7)	(76.2)	(7.1)	---	---	(25.4)	
30UV43V-SOG	Vee	2.00"	1.00"	2.12"	4.89"	1.50"	1.12"	0.69"	0.38"	3.00"	0.28"	---	---	1.00"	3
30UV43R-SOG	Reg	(50.8)	(25.4)	(53.8)	(124.2)	(38.1)	(28.4)	(17.5)	(9.7)	(76.2)	(7.1)	---	---	(25.4)	
30UV44V-SOG	Vee	2.00"	1.00"	2.00"	4.77"	1.12"	1.12"	0.69"	0.38"	3.00"	0.28"	---	---	1.00"	4
30UV44R-SOG	Reg	(50.8)	(25.4)	(50.8)	(121.2)	(28.4)	(28.4)	(17.5)	(9.7)	(76.2)	(7.1)	---	---	(25.4)	
30UV45V-SOG	Vee	2.00"	1.00"	3.06"	8.60"	1.53"	1.12"	0.69"	0.38"	3.00"	0.28"	---	---	1.00"	5
30UV45R-SOG	Reg	(50.8)	(25.4)	(77.7)	(218.4)	(38.9)	(28.4)	(17.5)	(9.7)	(76.2)	(7.1)	---	---	(25.4)	
30UV46V-SOG	Vee	2.00"	1.00"	2.38"	5.15"	---	1.12"	0.69"	0.38"	3.00"	0.28"	0.75"	1.47"	1.00"	6
30UV46R-SOG	Reg	(50.8)	(25.4)	(60.5)	(130.8)	---	(28.4)	(17.5)	(9.7)	(76.2)	(7.1)	(19.1)	(37.3)	(25.4)	

See page SOG-1 for orifice and Cv

3-way One on Pressure

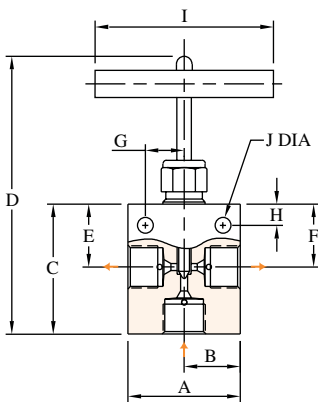

Figure 4

2-stem Manifold

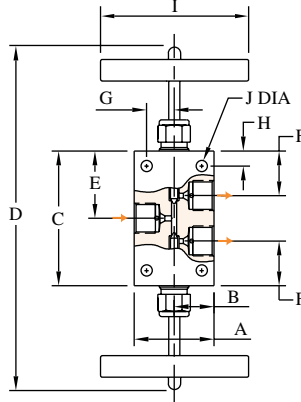

Figure 5

Replaceable Seat

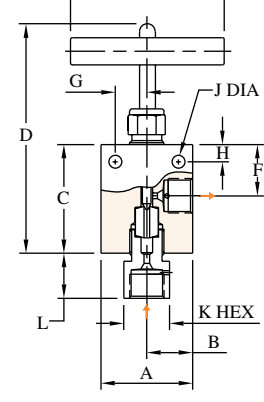

Figure 6

NEEDLE VALVES FOR 20,000 PSI (1380 BAR)

**3/8" H/P TUBE
CONED AND THREADED**

2-way Straight

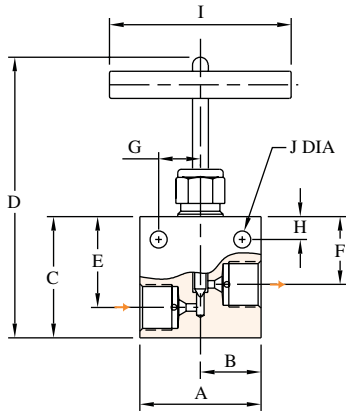

Figure 1

2-way Angle

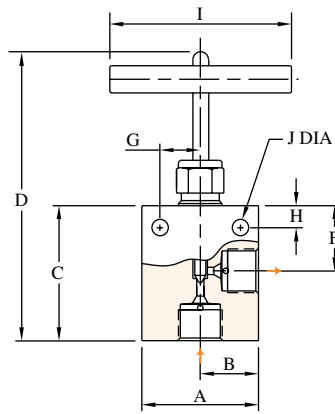

Figure 2

3-way Two on Pressure

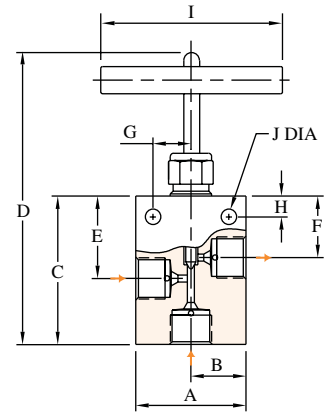

Figure 3

Catalog Number	Stem Style	A	B	C	D	E	F	G	H	I	J	K	L	Thk.	Fig
30UV61V-SOG	Vee	2.00"	1.00"	2.00"	4.77"	1.50"	1.12"	0.69"	0.38"	3.00"	0.28"	---	---	1.00"	1
30UV61R-SOG	Reg	(50.8)	(25.4)	(50.8)	(121.2)	(38.1)	(28.4)	(17.5)	(9.7)	(76.2)	(7.1)	---	---	(25.4)	
30UV62V-SOG	Vee	2.00"	1.00"	2.12"	4.89"	---	1.12"	0.69"	0.38"	3.00"	0.28"	---	---	1.00"	2
30UV62R-SOG	Reg	(50.8)	(25.4)	(53.8)	(124.2)	---	(28.4)	(17.5)	(9.7)	(76.2)	(7.1)	---	---	(25.4)	
30UV63V-SOG	Vee	2.00"	1.00"	2.50"	5.32"	1.50"	1.12"	0.69"	0.38"	3.00"	0.28"	---	---	1.00"	3
30UV63R-SOG	Reg	(50.8)	(25.4)	(63.5)	(135.1)	(38.1)	(28.4)	(17.5)	(9.7)	(76.2)	(7.1)	---	---	(25.4)	
30UV64V-SOG	Vee	2.00"	1.00"	2.12"	4.89"	1.12"	1.12"	0.69"	0.38"	3.00"	0.28"	---	---	1.00"	4
30UV64R-SOG	Reg	(50.8)	(25.4)	(53.8)	(124.2)	(28.4)	(28.4)	(17.5)	(9.7)	(76.2)	(7.1)	---	---	(25.4)	
30UV65V-SOG	Vee	2.00"	1.00"	3.25"	8.79"	1.62"	1.12"	0.69"	0.38"	3.00"	0.28"	---	---	1.00"	5
30UV65R-SOG	Reg	(50.8)	(25.4)	(82.6)	(223.3)	(41.1)	(28.4)	(17.5)	(9.7)	(76.2)	(7.1)	---	---	(25.4)	
30UV66V-SOG	Vee	2.00"	1.00"	2.38"	5.15"	---	1.12"	0.69"	0.38"	3.00"	0.28"	1.00"	1.15"	1.00"	6
30UV66R-SOG	Reg	(50.8)	(25.4)	(60.5)	(130.8)	---	(28.4)	(17.5)	(9.7)	(76.2)	(7.1)	(25.4)	(29.2)	(25.4)	

See page SOG-1 for orifice and Cv

3-way One on Pressure

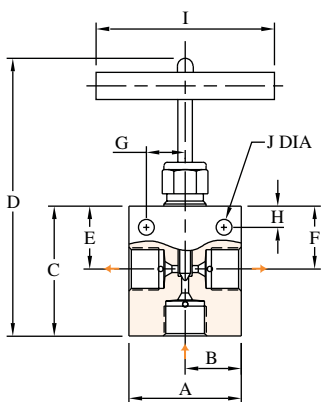

Figure 4

2-stem Manifold

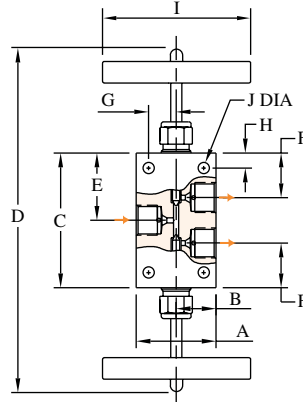

Figure 5

Replaceable Seat

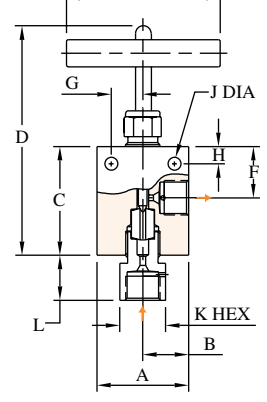

Figure 6

All dimensions are for reference only and are subject to change.
Dimensions in parentheses are millimeters (mm)

NEEDLE VALVES FOR 20,000 PSI (1380 BAR)

9/16" H/P TUBE
CONED AND THREADED

2-way Straight

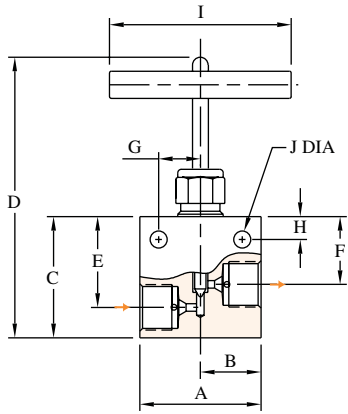

Figure 1

2-way Angle

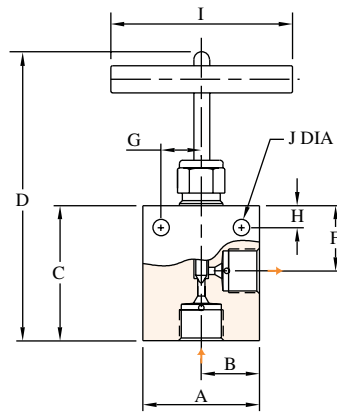

Figure 2

3-way Two on Pressure

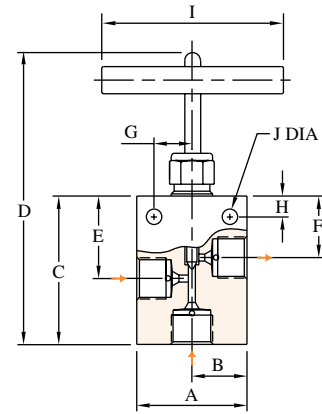

Figure 3

Catalog Number	Stem Style	A	B	C	D	E	F	G	H	I	J	K	L	Thk.	Fig
30UV91V-SOG	Vee	2.62"	1.31"	2.44"	5.20"	1.56"	1.12"	0.69"	0.38"	3.00"	0.25"	---	---	1.50"	1
30UV91R-SOG	Reg	(66.5)	(33.3)	(62.0)	(132.1)	(39.6)	(28.4)	(17.5)	(9.7)	(76.2)	(6.4)	---	---	(38.1)	
30UV92V-SOG	Vee	2.62"	1.31"	3.00"	5.44"	---	1.62"	0.69"	0.38"	3.00"	0.28"	---	---	1.50"	2
30UV92R-SOG	Reg	(66.5)	(33.3)	(76.2)	(138.2)	---	(41.1)	(17.5)	(9.7)	(76.2)	(7.1)	---	---	(38.1)	
30UV93V-SOG	Vee	2.62"	1.31"	2.88"	5.65"	1.56"	1.12"	0.69"	0.38"	3.00"	0.28"	---	---	1.50"	3
30UV93R-SOG	Reg	(66.5)	(33.3)	(73.2)	(143.5)	(39.6)	(28.4)	(17.5)	(9.7)	(76.2)	(7.1)	---	---	(38.1)	
30UV94V-SOG	Vee	2.62"	1.31"	2.44"	5.21"	1.12"	1.12"	0.69"	0.38"	3.00"	0.28"	---	---	1.50"	4
30UV94R-SOG	Reg	(66.5)	(33.3)	(62.0)	(132.3)	(28.4)	(28.4)	(17.5)	(9.7)	(76.2)	(7.1)	---	---	(38.1)	
30UV95V-SOG	Vee	2.62"	1.31"	4.75"	10.29"	2.38"	1.62"	0.69"	0.50"	3.00"	0.28"	---	---	1.50"	5
30UV95R-SOG	Reg	(66.5)	(33.3)	(120.7)	(261.4)	(60.5)	(41.1)	(17.5)	(12.7)	(76.2)	(7.1)	---	---	(38.1)	
30UV96V-SOG	Vee	2.62"	1.31"	2.44"	5.21"	---	1.19"	0.69"	0.38"	3.00"	0.28"	1.38"	1.65"	1.50"	6
30UV96R-SOG	Reg	(66.5)	(33.3)	(62.0)	(132.3)	---	(30.2)	(17.5)	(9.7)	(76.2)	(7.1)	(35.1)	(41.9)	(38.1)	

See page SOG-1 for orifice and Cv

3-way One on Pressure

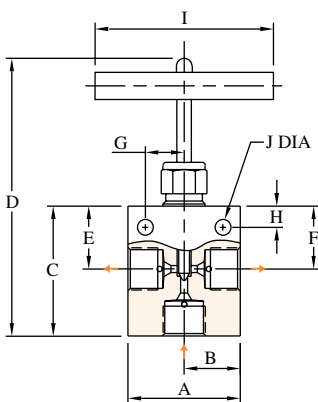

Figure 4

2-stem Manifold

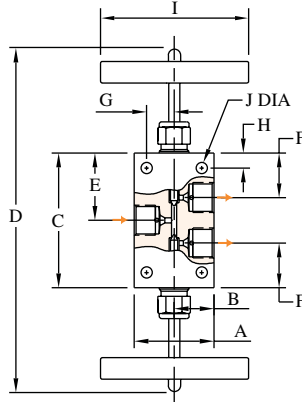

Figure 5

Replaceable Seat

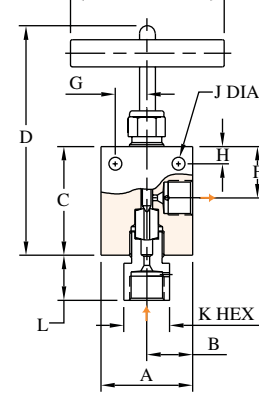

Figure 6

NEEDLE VALVES FOR 30,000 PSI (2070 BAR)

1/4" H/P TUBE
CONED AND THREADED

2-way Straight

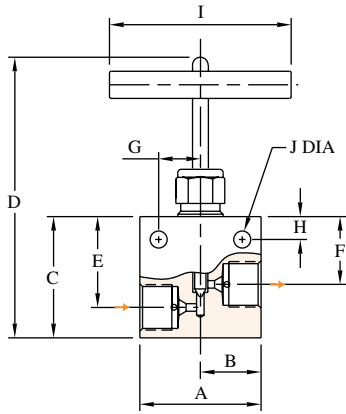

Figure 1

2-way Angle

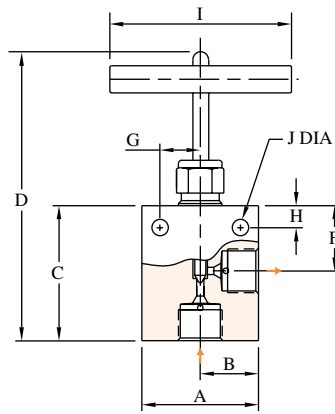

Figure 2

3-way Two on Pressure

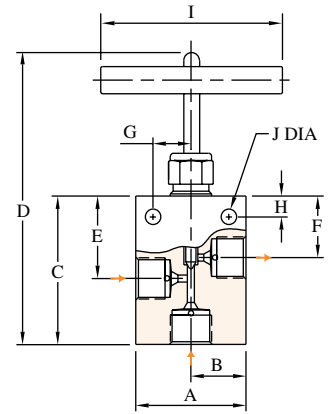

Figure 3

Catalog Number	Stem Style	A	B	C	D	E	F	G	H	I	J	K	L	Thk.	Fig
60UV41V-SOG	Vee	2.00"	1.00"	2.12"	4.90"	1.69"	1.31"	0.69"	0.38"	3.00"	0.25"	---	---	1.00"	1
60UV41R-SOG	Reg	(50.8)	(25.4)	(53.8)	(124.5)	(42.9)	(33.3)	(17.5)	(9.7)	(76.2)	(6.4)	---	---	(25.4)	
60UV42V-SOG	Vee	2.00"	1.00"	2.38"	5.16"	---	1.31"	0.69"	0.38"	3.00"	0.25"	---	---	1.00"	2
60UV42R-SOG	Reg	(50.8)	(25.4)	(60.5)	(131.1)	---	(33.3)	(17.5)	(9.7)	(76.2)	(6.4)	---	---	(25.4)	
60UV43V-SOG	Vee	2.00"	1.00"	2.38"	5.16"	1.69"	1.31"	0.69"	0.38"	3.00"	0.25"	---	---	1.00"	3
60UV43R-SOG	Reg	(50.8)	(25.4)	(60.5)	(131.1)	(42.9)	(33.3)	(17.5)	(9.7)	(76.2)	(6.4)	---	---	(25.4)	
60UV44V-SOG	Vee	2.00"	1.00"	2.38"	5.16"	1.31"	1.31"	0.69"	0.38"	3.00"	0.25"	---	---	1.00"	4
60UV44R-SOG	Reg	(50.8)	(25.4)	(60.5)	(131.1)	(33.3)	(33.3)	(17.5)	(9.7)	(76.2)	(6.4)	---	---	(25.4)	
60UV45V-SOG	Vee	2.00"	1.00"	3.44"	9.00"	1.72"	1.31"	0.69"	0.38"	3.00"	0.25"	---	---	1.00"	5
60UV45R-SOG	Reg	(50.8)	(25.4)	(87.4)	(228.6)	(43.7)	(33.3)	(17.5)	(9.7)	(76.2)	(6.4)	---	---	(25.4)	
60UV46V-SOG	Vee	2.00"	1.00"	2.62"	5.40"	---	1.31"	0.69"	0.38"	3.00"	0.25"	0.75"	1.29"	1.00"	6
60UV46R-SOG	Reg	(50.8)	(25.4)	(66.5)	(137.2)	---	(33.3)	(17.5)	(9.7)	(76.2)	(6.4)	(19.1)	(32.8)	(25.4)	

See page SOG-1 for orifice and Cv

3-way One on Pressure

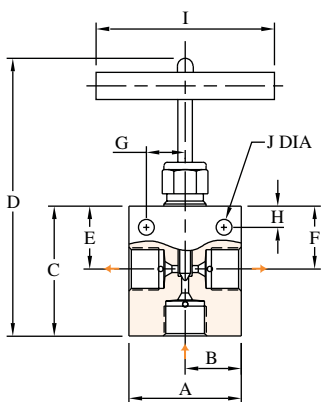

Figure 4

2-stem Manifold

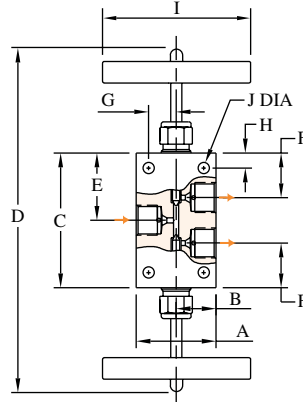

Figure 5

Replaceable Seat

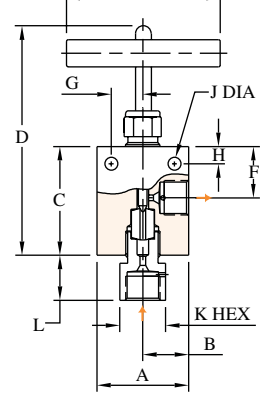

Figure 6

All dimensions are for reference only and are subject to change.
Dimensions in parentheses are millimeters (mm)

NEEDLE VALVES FOR 30,000 PSI (2070 BAR)

3/8" H/P TUBE
CONED AND THREADED

2-way Straight

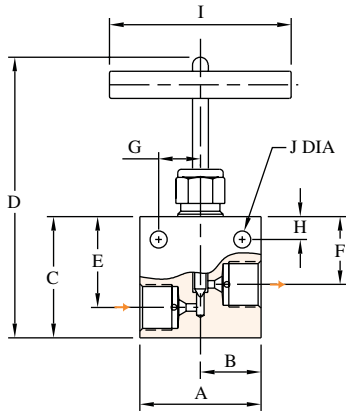

Figure 1

2-way Angle

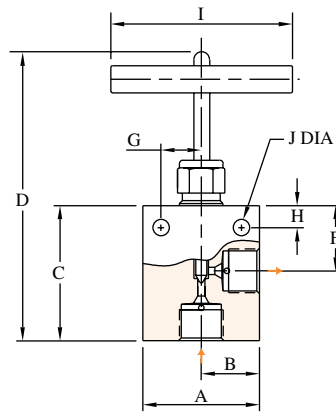

Figure 2

3-way Two on Pressure

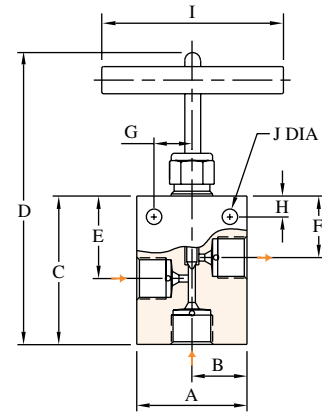

Figure 3

Catalog Number	Stem Style	A	B	C	D	E	F	G	H	I	J	K	L	Thk.	Fig
60UV61V-SOG	Vee	2.00"	1.00"	2.25"	5.03"	1.69"	1.31"	0.69"	0.38"	3.00"	0.25"	---	---	1.00"	1
60UV61R-SOG	Reg	(50.8)	(25.4)	(57.2)	(127.8)	(42.9)	(33.3)	(17.5)	(9.7)	(76.2)	(6.4)	---	---	(25.4)	
60UV62V-SOG	Vee	2.00"	1.00"	2.62"	5.40"	---	1.31"	0.69"	0.38"	3.00"	0.25"	---	---	1.00"	2
60UV62R-SOG	Reg	(50.8)	(25.4)	(66.5)	(137.2)	---	(33.3)	(17.5)	(9.7)	(76.2)	(6.4)	---	---	(25.4)	
60UV63V-SOG	Vee	2.00"	1.00"	2.75"	5.53"	1.69"	1.31"	0.69"	0.38"	3.00"	0.25"	---	---	1.00"	3
60UV63R-SOG	Reg	(50.8)	(25.4)	(69.9)	(140.5)	(42.9)	(33.3)	(17.5)	(9.7)	(76.2)	(6.4)	---	---	(25.4)	
60UV64V-SOG	Vee	2.00"	1.00"	2.62"	5.40"	1.31"	1.31"	0.69"	0.38"	3.00"	0.25"	---	---	1.00"	4
60UV64R-SOG	Reg	(50.8)	(25.4)	(66.5)	(137.2)	(33.3)	(33.3)	(17.5)	(9.7)	(76.2)	(6.4)	---	---	(25.4)	
60UV65V-SOG	Vee	2.00"	1.00"	3.75"	9.31"	1.88"	1.31"	0.69"	0.38"	3.00"	0.25"	---	---	1.00"	5
60UV65R-SOG	Reg	(50.8)	(25.4)	(95.3)	(236.5)	(47.8)	(33.3)	(17.5)	(9.7)	(76.2)	(6.4)	---	---	(25.4)	
60UV66V-SOG	Vee	2.00"	1.00"	2.62"	5.40"	---	1.31"	0.69"	0.38"	3.00"	0.25"	1.00"	1.21"	1.00"	6
60UV66R-SOG	Reg	(50.8)	(25.4)	(66.5)	(137.2)	---	(33.3)	(17.5)	(9.7)	(76.2)	(6.4)	(25.4)	(30.7)	(25.4)	

See page SOG-1 for orifice and Cv

3-way One on Pressure

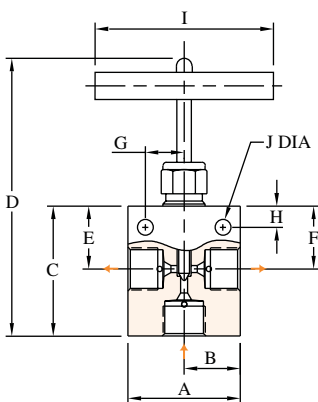

Figure 4

2-stem Manifold

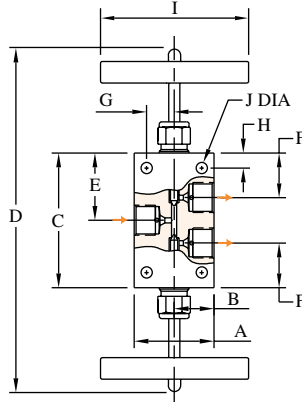

Figure 5

Replaceable Seat

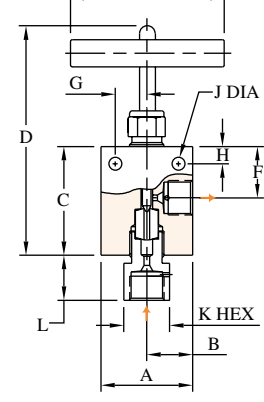

Figure 6

NEEDLE VALVES FOR 30,000 PSI (2070 BAR)

**9/16" H/P TUBE
CONED AND THREADED**

2-way Straight

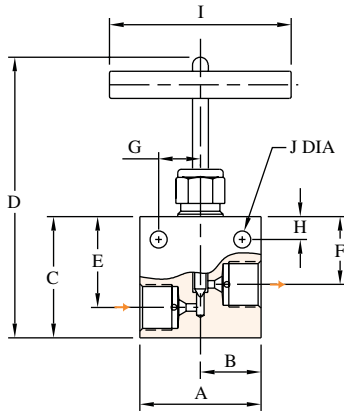

Figure 1

2-way Angle

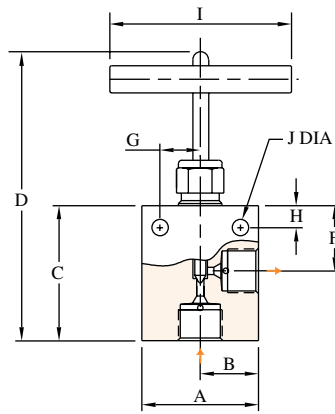

Figure 2

3-way Two on Pressure

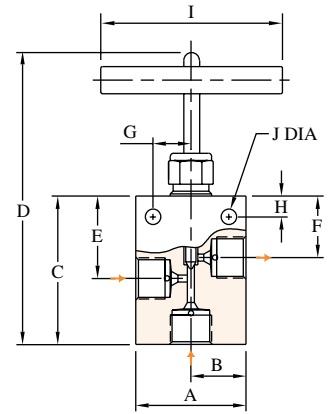

Figure 3

Catalog Number	Stem Style	A	B	C	D	E	F	G	H	I	J	K	L	Thk.	Fig
60UV91V-SOG	Vee	2.62"	1.31"	2.50"	5.28"	1.69"	1.31"	0.69"	0.38"	3.00"	0.28"	---	---	1.50"	1
60UV91R-SOG	Reg	(66.5)	(33.3)	(63.5)	(134.1)	(42.9)	(33.3)	(17.5)	(9.7)	(76.2)	(7.1)	---	---	(38.1)	
60UV92V-SOG	Vee	2.62"	1.31"	2.81"	5.59"	---	1.31"	0.69"	0.38"	3.00"	0.28"	---	---	1.50"	2
60UV92R-SOG	Reg	(66.5)	(33.3)	(71.4)	(142.0)	---	(33.3)	(17.5)	(9.7)	(76.2)	(7.1)	---	---	(38.1)	
60UV93V-SOG	Vee	2.62"	1.31"	3.03"	5.81"	1.75"	1.31"	0.69"	0.38"	3.00"	0.28"	---	---	1.50"	3
60UV93R-SOG	Reg	(66.5)	(33.3)	(77.0)	(147.6)	(44.5)	(33.3)	(17.5)	(9.7)	(76.2)	(7.1)	---	---	(38.1)	
60UV94V-SOG	Vee	2.62"	1.31"	2.81"	5.59"	1.31"	1.31"	0.69"	0.38"	3.00"	0.28"	---	---	1.50"	4
60UV94R-SOG	Reg	(66.5)	(33.3)	(71.4)	(142.0)	(33.3)	(33.3)	(17.5)	(9.7)	(76.2)	(7.1)	---	---	(38.1)	
60UV95V-SOG	Vee	2.62"	1.31"	4.12"	9.68"	2.06"	1.31"	0.69"	0.50"	3.00"	0.28"	---	---	1.50"	5
60UV95R-SOG	Reg	(66.5)	(33.3)	(104.6)	(245.9)	(52.3)	(33.3)	(17.5)	(12.7)	(76.2)	(7.1)	---	---	(38.1)	
60UV96V-SOG	Vee	2.62"	1.31"	2.62"	5.40"	---	1.31"	0.69"	0.38"	3.00"	0.28"	1.38"	1.39"	1.50"	6
60UV96R-SOG	Reg	(66.5)	(33.3)	(66.5)	(137.2)	---	(33.3)	(17.5)	(9.7)	(76.2)	(7.1)	(35.1)	(35.3)	(38.1)	

See page SOG-1 for orifice and Cv

3-way One on Pressure

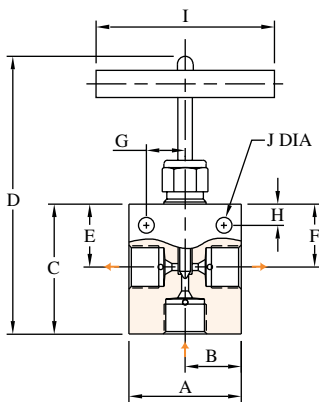

Figure 4

2-stem Manifold

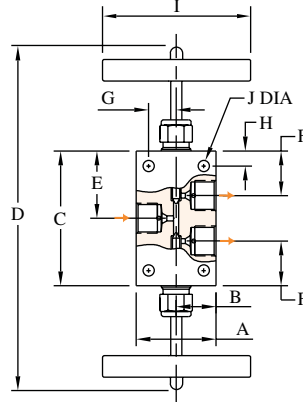

Figure 5

Replaceable Seat

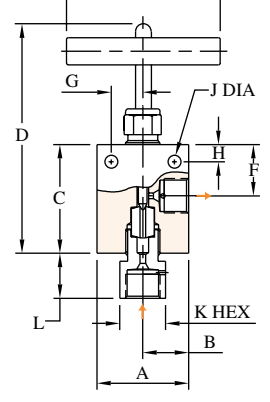
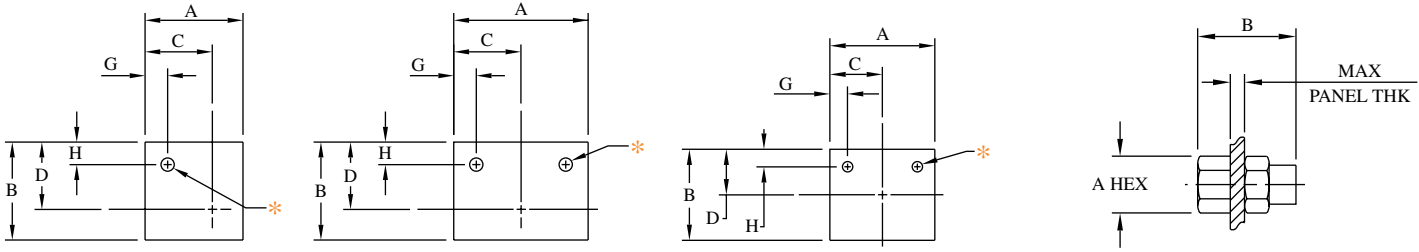

Figure 6

All dimensions are for reference only and are subject to change.
Dimensions in parentheses are millimeters (mm)

SOUR GAS EQUIPMENT



ELBOWS

Catalog				Block					Mounting Holes*		
Number	Connection	Port	MAWP	A	B	C	D	Thickness	G	H	Dia.
60L4-SOG	1/4" H/P Tube	0.093" (2.4)	30,000 PSI 2070 bar	1.50" (38.1)	1.00" (25.4)	0.88" (22.4)	0.63" (16.0)	0.75" (19.1)	0.25" (6.4)	0.15" (3.8)	0.22" (5.6)
60L6-SOG	3/8" H/P Tube	0.125" (3.2)	30,000 PSI 2070 bar	2.00" (50.8)	1.50" (38.1)	1.25" (31.8)	1.00" (25.4)	1.00" (25.4)	0.38" (9.7)	0.31" (7.9)	0.22" (5.6)
60L9-SOG	9/16" H/P Tube	0.187" (4.7)	30,000 PSI 2070 bar	2.62" (66.5)	1.88" (47.8)	1.88" (47.8)	1.13" (28.6)	1.50" (38.1)	2.32" (58.9)	1.38" (35.1)	0.28" (7.1)

TEES

Catalog				Block					Mounting Holes*		
Number	Connection	Port	MAWP	A	B	C	D	Thickness	G	H	Dia.
60T4-SOG	1/4" H/P Tube	0.093" (2.4)	30,000 PSI 2070 bar	2.00" (50.8)	1.25" (31.8)	1.00" (25.4)	0.88" (22.4)	1.00" (25.4)	0.25" (6.4)	0.12" (3.0)	0.17" (4.3)
60T6-SOG	3/8" H/P Tube	0.125" (3.2)	30,000 PSI 2070 bar	2.00" (50.8)	1.56" (39.6)	1.00" (25.4)	1.06" (26.9)	1.00" (25.4)	0.31" (7.9)	0.31" (7.9)	0.22" (5.6)
60T9-SOG	9/16" H/P Tube	0.187" (4.7)	30,000 PSI 2070 bar	2.62" (66.5)	2.12" (53.8)	1.31" (33.3)	1.38" (35.1)	1.50" (38.1)	0.37" (9.4)	0.38" (9.5)	0.28" (7.1)

CROSSES

Catalog				Block					Mounting Holes*		
Number	Connection	Port	MAWP	A	B	C	D	Thickness	G	H	Dia.
60X4-SOG	1/4" H/P Tube	0.093" (2.4)	30,000 PSI 2070 bar	2.00" (50.8)	1.25" (31.8)	1.00" (25.4)	0.62" (15.7)	1.00" (25.4)	0.25" (6.4)	0.12" (3.0)	0.17" (4.3)
60X6-SOG	3/8" H/P Tube	0.125" (3.2)	30,000 PSI 2070 bar	2.00" (50.8)	2.12" (53.8)	1.00" (25.4)	1.06" (26.9)	1.00" (25.4)	0.31" (7.9)	0.31" (7.9)	0.22" (5.6)
60X9-SOG	9/16" H/P Tube	0.187" (4.7)	30,000 PSI 2070 bar	2.62" (66.5)	2.75" (69.9)	1.31" (33.3)	1.38" (35.1)	1.50" (38.1)	0.38" (9.7)	0.38" (9.5)	0.28" (7.1)

BULKHEADS

Catalog				Max Panel			Panel
Number	Connection	Port	MAWP	A	B	Thickness	Hole
60BF4-SOG	1/4" H/P Tube	0.093" (2.4)	30,000 PSI 2070 bar	1.00" (25.4)	2.00" (50.8)	0.50" (12.7)	0.81" (20.6)
60BF6-SOG	3/8" H/P Tube	0.125" (3.2)	30,000 PSI 2070 bar	1.38" (35.1)	2.38" (60.5)	0.38" (9.7)	1.12" (28.4)
60BF9-SOG	9/16" H/P Tube	0.187" (4.7)	30,000 PSI 2070 bar	1.87" (47.5)	2.75" (69.9)	0.62" (15.7)	1.75" (44.5)

*Mounting holes provided when the catalog number is suffixed by "-MH" when ordering.

All dimensions are for reference only and are subject to change.
Dimensions in parentheses are millimeters (mm)

SOUR GAS COUPLINGS

COUPLINGS, H/P TUBE TO H/P TUBE

Catalog Number	Female H/P	Female H/P	Port	MAWP	A	B
60F4-SOG	1/4"	1/4"	0.093" (2.4)	30,000 PSI 2070 bar	0.75" (19.1)	1.38" (35.1)
60F4H6H-SOG	1/4"	3/8"	0.093" (2.4)	30,000 PSI 2070 bar	1.00" (25.4)	1.75" (44.5)
60F4H9H-SOG	1/4"	9/16"	0.093" (2.4)	30,000 PSI 2070 bar	1.38" (35.1)	2.25" (57.2)
60F6-SOG	3/8"	3/8"	0.125" (3.2)	30,000 PSI 2070 bar	1.00" (25.4)	1.75" (44.5)
60F6H9H-SOG	3/8"	9/16"	0.125" (3.2)	30,000 PSI 2070 bar	1.38" (35.1)	2.25" (57.2)
60F9-SOG	9/16"	9/16"	0.187" (4.7)	30,000 PSI 2070 bar	1.38" (35.1)	2.25" (57.2)

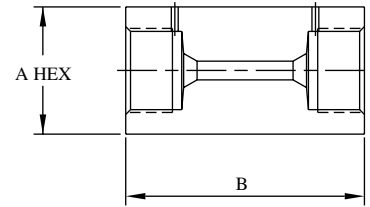

COUPLINGS, H/P TUBE TO PIPE

Catalog Number	Female H/P	Female NPT	Port	MAWP	A	B
10F4H2P-SOG	1/4"	1/8"	0.093" (2.4)	10,000 PSI 690 bar	0.75" (19.1)	1.50" (38.1)
10F4H4P-SOG	1/4"	1/4"	0.093" (2.4)	10,000 PSI 690 bar	0.75" (19.1)	1.50" (38.1)
10F4H6P-SOG	1/4"	3/8"	0.093" (2.4)	10,000 PSI 690 bar	1.00" (25.4)	1.62" (41.1)
10F4H8P-SOG	1/4"	1/2"	0.093" (2.4)	10,000 PSI 690 bar	1.38" (35.1)	2.12" (53.8)
10F6H2P-SOG	3/8"	1/8"	0.125" (3.2)	10,000 PSI 690 bar	1.00" (25.4)	1.75" (44.5)
10F6H4P-SOG	3/8"	1/4"	0.125" (3.2)	10,000 PSI 690 bar	1.00" (25.4)	1.75" (44.5)
10F6H6P-SOG	3/8"	3/8"	0.125" (3.2)	10,000 PSI 690 bar	1.00" (25.4)	1.75" (44.5)
10F6H8P-SOG	3/8"	1/2"	0.125" (3.2)	10,000 PSI 690 bar	1.38" (35.1)	2.12" (53.8)
10F9H2P-SOG	9/16"	1/8"	0.187" (4.7)	10,000 PSI 690 bar	1.38" (35.1)	2.25" (57.2)
10F9H4P-SOG	9/16"	1/4"	0.187" (4.7)	10,000 PSI 690 bar	1.38" (35.1)	2.25" (57.2)
10F9H6P-SOG	9/16"	3/8"	0.187" (4.7)	10,000 PSI 690 bar	1.38" (35.1)	2.25" (57.2)
10F9H8P-SOG	9/16"	1/2"	0.187" (4.7)	10,000 PSI 690 bar	1.38" (35.1)	2.25" (57.2)

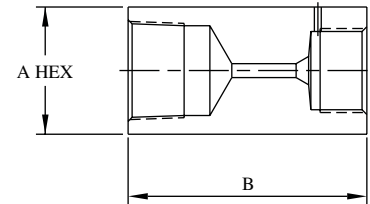

REPLACEABLE SEAT COUPLINGS

Catalog Number	Connection	Port	MAWP	A	B
60UF4-SOG	1/4" H/P Tube	0.093" (2.4)	30,000 PSI 2070 bar	0.75" (19.1)	1.50" (38.1)
60UF6-SOG	3/8" H/P Tube	0.125" (3.2)	30,000 PSI 2070 bar	1.38" (35.1)	1.75" (44.5)
60UF9-SOG	9/16" H/P Tube	0.187" (4.7)	30,000 PSI 2070 bar	1.38" (35.1)	2.25" (57.2)

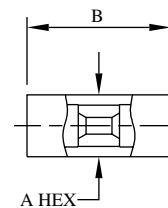

All dimensions are for reference only and are subject to change.
Dimensions in parentheses are millimeters (mm)

SOUR GAS ADAPTERS

H/P Male X NPT Female

Catalog Number	Male H/P	Female NPT	Port	MAWP	A	B
10A4H2P-SOG	1/4"	1/8"	0.125" (3.2)	10,000 PSI 690 bar	0.63" (16.0)	1.43" (36.3)
10A4H4P-SOG	1/4"	1/4"	0.125" (3.2)	10,000 PSI 690 bar	0.75" (19.1)	1.68" (42.7)
10A4H6P-SOG	1/4"	3/8"	0.125" (3.2)	10,000 PSI 690 bar	1.00" (25.4)	1.68" (42.7)
10A4H8P-SOG	1/4"	1/2"	0.125" (3.2)	10,000 PSI 690 bar	1.38" (35.1)	1.93" (49.0)
10A6H2P-SOG	3/8"	1/8"	0.218" (5.5)	10,000 PSI 690 bar	0.75" (19.1)	1.75" (44.5)
10A6H4P-SOG	3/8"	1/4"	0.218" (5.5)	10,000 PSI 690 bar	1.00" (25.4)	2.00" (50.8)
10A6H6P-SOG	3/8"	3/8"	0.218" (5.5)	10,000 PSI 690 bar	1.00" (25.4)	2.00" (50.8)
10A6H8P-SOG	3/8"	1/2"	0.218" (5.5)	10,000 PSI 690 bar	1.38" (35.1)	2.38" (60.5)
10A9H2P-SOG	9/16"	1/8"	0.281" (7.1)	10,000 PSI 690 bar	1.18" (30.0)	2.06" (52.3)
10A9H4P-SOG	9/16"	1/4"	0.281" (7.1)	10,000 PSI 690 bar	1.18" (30.0)	2.06" (52.3)
10A9H6P-SOG	9/16"	3/8"	0.281" (7.1)	10,000 PSI 690 bar	1.18" (30.0)	2.06" (52.3)
10A9H8P-SOG	9/16"	1/2"	0.281" (7.1)	10,000 PSI 690 bar	1.38" (35.1)	2.06" (52.3)
10A9H12P-SOG	9/16"	3/4"	0.281" (7.1)	10,000 PSI 690 bar	1.75" (44.5)	2.69" (68.3)

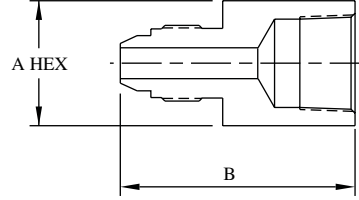

NPT Male X H/P Female

Catalog Number	Male NPT	Female H/P	Port	MAWP	A	B
10A2P4H-SOG	1/8"	1/4"	0.093" (2.4)	10,000 PSI 690 bar	0.75" (19.1)	1.50" (38.1)
10A2P6H-SOG	1/8"	3/8"	0.125" (3.2)	10,000 PSI 690 bar	1.00" (25.4)	1.75" (44.5)
10A2P9H-SOG	1/8"	9/16"	0.187" (4.7)	10,000 PSI 690 bar	1.38" (35.1)	2.25" (57.2)
10A4P4H-SOG	1/4"	1/4"	0.093" (2.4)	10,000 PSI 690 bar	0.75" (19.1)	1.50" (38.1)
10A4P6H-SOG	1/4"	3/8"	0.125" (3.2)	10,000 PSI 690 bar	1.00" (25.4)	1.75" (44.5)
10A4P9H-SOG	1/4"	9/16"	0.187" (4.7)	10,000 PSI 690 bar	1.38" (35.1)	2.25" (57.2)
10A6P4H-SOG	3/8"	1/4"	0.093" (2.4)	10,000 PSI 690 bar	0.75" (19.1)	1.50" (38.1)
10A6P6H-SOG	3/8"	3/8"	0.125" (3.2)	10,000 PSI 690 bar	1.00" (25.4)	1.75" (44.5)
10A6P9H-SOG	3/8"	9/16"	0.187" (4.7)	10,000 PSI 690 bar	1.38" (35.1)	2.25" (57.2)
10A8P4H-SOG	1/2"	1/4"	0.093" (2.4)	10,000 PSI 690 bar	1.00" (25.4)	1.62" (41.1)
10A8P6H-SOG	1/2"	3/8"	0.125" (3.2)	10,000 PSI 690 bar	1.00" (25.4)	1.75" (44.5)
10A8P9H-SOG	1/2"	9/16"	0.187" (4.7)	10,000 PSI 690 bar	1.38" (35.1)	2.25" (57.2)
10A12P9H-SOG	3/4"	9/16"	0.187" (4.7)	10,000 PSI 690 bar	1.38" (35.1)	2.25" (57.2)
10A16P4H-SOG	1"	1/4"	0.093" (2.4)	10,000 PSI 690 bar	1.38" (35.1)	1.75" (44.5)

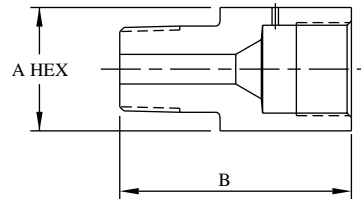

All dimensions are for reference only and are subject to change.
Dimensions in parentheses are millimeters (mm)

SOUR GAS ADAPTERS

H/P Male X H/P Female

Catalog Number	Male H/P	Female H/P	Port	MAWP	A	B
60A4H4H-SOG	1/4"	1/4"	0.093" (2.4)	30,000 PSI 2070 bar	0.75" (19.1)	1.43" (36.3)
60A4H6H-SOG	1/4"	3/8"	0.125" (3.2)	30,000 PSI 2070 bar	1.00" (25.4)	1.93" (49.0)
60A4H9H-SOG	1/4"	9/16"	0.125" (3.2)	30,000 PSI 2070 bar	1.38" (35.1)	2.43" (61.7)
60A6H4H-SOG	3/8"	1/4"	0.093" (2.4)	30,000 PSI 2070 bar	0.75" (19.1)	1.75" (44.5)
60A6H9H-SOG	3/8"	9/16"	0.188" (4.8)	30,000 PSI 2070 bar	1.38" (35.1)	2.50" (63.5)
60A9H4H-SOG	9/16"	1/4"	0.093" (2.4)	30,000 PSI 2070 bar	1.18" (30.0)	2.06" (52.3)
60A9H6H-SOG	9/16"	3/8"	0.125" (3.2)	30,000 PSI 2070 bar	1.18" (30.0)	2.06" (52.3)
60A9H9H-SOG	9/16"	9/16"	0.188" (4.8)	30,000 PSI 2070 bar	1.38" (35.1)	2.56" (65.0)

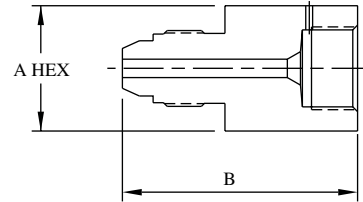

H/P Male X H/P Male

Catalog Number	Male H/P	Male H/P	Port	MAWP	A	B
MA4H4H-SOG	1/4"	1/4"	0.125" (3.2)	30,000 PSI 2070 bar	0.75" (19.1)	2.12" (53.8)
MA6H4H-SOG	3/8"	1/4"	0.082" (2.1)	30,000 PSI 2070 bar	0.75" (19.1)	2.42" (61.5)
MA6H6H-SOG	3/8"	3/8"	0.218" (5.5)	30,000 PSI 2070 bar	0.75" (19.1)	2.50" (63.5)
MA9H4H-SOG	9/16"	1/4"	0.125" (3.2)	30,000 PSI 2070 bar	1.13" (28.7)	2.99" (75.9)
MA9H6H-SOG	9/16"	3/8"	0.218" (5.5)	30,000 PSI 2070 bar	1.18" (30.0)	3.06" (77.7)
MA9H9H-SOG	9/16"	9/16"	0.218" (5.5)	30,000 PSI 2070 bar	1.18" (30.0)	3.37" (85.6)

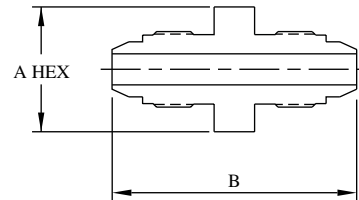

H/P Male X NPT Male

Catalog Number	Male H/P	Male NPT	Port	MAWP	A	B
MA4H2P-SOG	1/4"	1/8"	0.125" (3.2)	10,000 PSI 690 bar	1.00" (25.4)	2.18" (55.4)
MA4H4P-SOG	1/4"	1/4"	0.125" (3.2)	10,000 PSI 690 bar	1.00" (25.4)	2.18" (55.4)
MA4H6P-SOG	1/4"	3/8"	0.125" (3.2)	10,000 PSI 690 bar	0.75" (19.1)	1.86" (47.2)
MA4H8P-SOG	1/4"	1/2"	0.125" (3.2)	10,000 PSI 690 bar	1.00" (25.4)	2.18" (55.4)
MA6H2P-SOG	3/8"	1/8"	0.218" (5.5)	10,000 PSI 690 bar	1.38" (35.1)	2.75" (69.9)
MA6H4P-SOG	3/8"	1/4"	0.218" (5.5)	10,000 PSI 690 bar	1.00" (25.4)	2.75" (69.9)
MA6H6P-SOG	3/8"	3/8"	0.218" (5.5)	10,000 PSI 690 bar	0.81" (20.6)	2.19" (55.6)
MA6H8P-SOG	3/8"	1/2"	0.125" (3.2)	10,000 PSI 690 bar	1.00" (25.4)	3.00" (76.2)
MA9H2P-SOG	9/16"	1/8"	0.281" (7.1)	10,000 PSI 690 bar	1.13" (28.7)	2.81" (71.4)
MA9H4P-SOG	9/16"	1/4"	0.250" (6.4)	10,000 PSI 690 bar	1.13" (28.7)	2.81" (71.4)
MA9H6P-SOG	9/16"	3/8"	0.281" (7.1)	10,000 PSI 690 bar	1.13" (28.7)	2.81" (71.4)
MA9H8P-SOG	9/16"	1/2"	0.188" (4.8)	10,000 PSI 690 bar	1.18" (30.0)	3.00" (76.2)
MA9H12P-SOG	9/16"	3/4"	0.281" (7.1)	10,000 PSI 690 bar	1.13" (28.7)	2.63" (66.8)

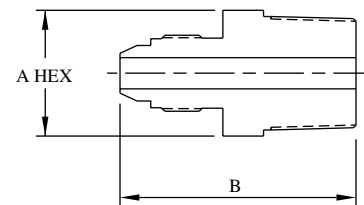

All dimensions are for reference only and are subject to change.
Dimensions in parentheses are millimeters (mm)

SOUR GAS NIPPLES AND TUBING

Coned and Threaded Nipples

BuTech stocks pre-cut coned and threaded nipples in lengths up to 12" (305 mm). In addition, nipples can be purchased to any custom length.

All nipples are 316 stainless steel, annealed in compliance with NACE MR0175 / ISO 15156.

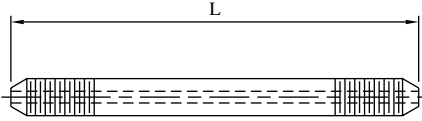

Connection	Length							MAWP
	2.75" (69.9)	3.00" (76.2)	4.00" (101.6)	6.00" (152.4)	8.00" (203.2)	10.00" (254.0)	12.00" (304.8)	
1/4" H/P	60N442-SOG	60N443-SOG	60N444-SOG	60N446-SOG	60N448-SOG	60N4410-SOG	60N4412-SOG	30,000 PSI 2070 bar
3/8" H/P		60N663-SOG	60N664-SOG	60N666-SOG	60N668-SOG	60N6610-SOG	60N6612-SOG	30,000 PSI 2070 bar
9/16" H/P			60N994-SOG	60N996-SOG	60N998-SOG	60N9910-SOG	60N9912-SOG	30,000 PSI 2070 bar

Tubing

Catalog Number	Connection	O.D.	I.D.	MAWP
60-083-316-SOG	1/4" H/P	0.250" (6.4)	0.083" (2.1)	30,000 PSI 2070 bar
60-125-316-SOG	3/8" H/P	0.375" (9.5)	0.125" (3.2)	30,000 PSI 2070 bar
60-188-316-SOG	9/16" H/P	0.562" (14.3)	0.188" (4.8)	30,000 PSI 2070 bar

BuTech offers a complete selection of austenitic seamless annealed stainless steel tubing for high pressure applications where both high strength and corrosion resistance are desired. Tubing is available in standard 20-24 foot lengths (6-7 meters), however, longer lengths are available on request.

All tubing is 316 stainless steel, annealed in compliance with NACE MR0175 / ISO 15156.



See Section T for Coning Tools, Threading Tools and Tube Vises!

SOUR GAS CONNECTION COMPONENTS

Connection Components

All BuTech valves and fittings for Sour Gas Service are supplied without glands and collars. To order these components separately, use catalog numbers listed below. When using a plug, the collar is not required.

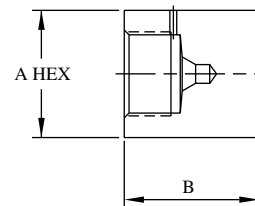

Tube Size	Collar	Gland	Plug
1/4" H/P	60C4-SOG	60G4-SOG	60P4-SOG
3/8" H/P	60C6-SOG	60G6-SOG	60P6-SOG
9/16" H/P	60C9-SOG	60G9-SOG	60P9-SOG

Cap	A	B	C	D
60CA4-SOG	0.75" (19.1)	1.06" (26.9)	0.63" (16.0)	0.60" (15.2)
60CA6-SOG	1.00" (25.4)	1.25" (31.8)	0.81" (20.6)	0.72" (18.3)
60CA9-SOG	1.38" (35.1)	1.62" (41.1)	1.18" (30.0)	0.96" (24.4)

Anti-Vibration Collet Glands

In standard high pressure connection systems, the bending stresses imposed by excessive vibration or shock on the the threaded area of the tubing may cause premature fatigue failure at the back of the thread. By using a BuTech Anti-Vibration Collet Gland, the stress concentration is transferred back to the unthreaded section of the tubing. This transfer and the spring-type gripping action of the collet, strengthens the entire assembly, resulting in virtually unlimited vibration fatigue life. Anti-Vibration Collet Glands are recommended whenever locating a valve or fitting on an unsupported line near a compressor, on equipment subjected to road vibrations, or areas where extreme shock is present.

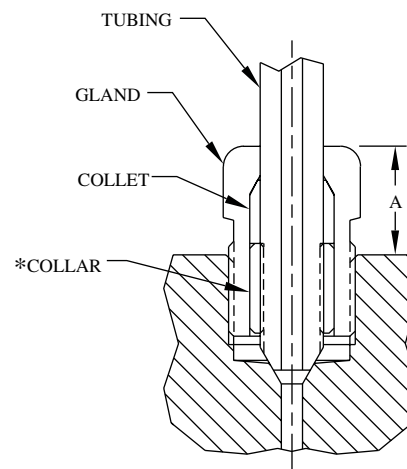

Connection	Catalog Number	Gland Hex Size	Height 'A'	Collar*
1/4" H/P	60AVG4-SOG	0.62" (15.7)	0.50" (12.7)	60C4
3/8" H/P	60AVG6-SOG	0.81" (20.6)	0.75" (19.1)	60C6
9/16" H/P	60AVG9-SOG	1.18" (30.0)	0.94" (23.9)	60C9

Anti-vibration glands are manufactured of 316 stainless steel and are available with an optional bonded dry-film Moly lubricant (add suffix **-MC** to catalog number)

*Collars are not included with anti-vibration assembly and must be ordered separately.

All dimensions are for reference only and are subject to change.
Dimensions in parentheses are millimeters (mm)

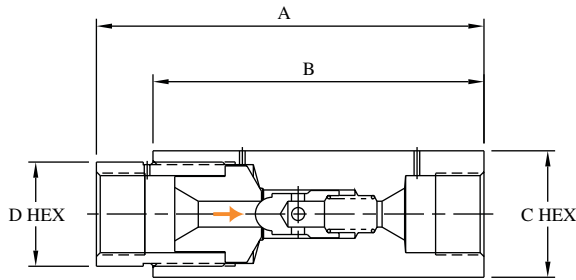

BuTech ball check valves prevent reverse flow where leak-tight shutoff is not necessary. Standard materials of construction are 316 stainless steel with Alloy 725 poppet for longer life, and 300 series stainless steel spring.

Note: For 316 stainless steel wetted parts, add **-316WP** to the catalog number.

Cracking pressure: 15 PSI (1 bar) approximate
 Operating Temperature Range:
 -420° to +1200°F
 (-251° to +648°C)

BALL CHECK VALVES

Catalog Number	Connection	MAWP	Cv	A	B	C	D
60BC4-SOG	1/4" H/P Tube	30,000 PSI 2070 bar	0.15	3.31" (84.1)	2.50" (63.5)	1.12" (28.4)	0.88" (22.4)
60BC6-SOG	3/8" H/P Tube	30,000 PSI 2070 bar	0.28	3.75" (95.3)	3.00" (76.2)	1.38" (35.1)	1.12" (28.4)
60BC9-SOG	9/16" H/P Tube	30,000 PSI 2070 bar	0.63	4.57" (116.1)	3.38" (85.9)	1.50" (38.1)	1.38" (35.1)

To order a valve with a cracking pressure other than the standard 15 PSI, add the cracking pressure to the end of the catalog number. Example: A 60BC9-SOG with 50 PSI cracking pressure would be ordered as **60BC9-SOG-50**.

Cracking pressures available up to 100 PSI (7 bar)

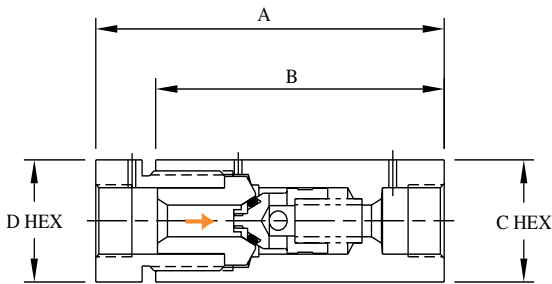

BuTech o-ring check valves reliably prevent backflow where leak-tight shutoff for liquids or gases is required. Standard materials of construction are 316 stainless steel with Buna-N o-ring and 300 series stainless steel spring.

Cracking pressure: 15 PSI (1 bar) approximate
 Operating Temperature Ranges:

O-ring Material	Operating Temperature Range	Catalog Suffix
Buna-N	-65° to +250°F (-54° to +121°C)	----
Viton	-40° to +500°F (-40° to +260°C)	-VA
PTFE	-320° to +400°F (-195° to +204°C)	-TFE
Kalrez	-20° to +550°F (-29° to +288°C)	-HT

O-RING CHECK VALVES

Catalog Number	Connection	MAWP	Cv	A	B	C	D
60SC4-SOG	1/4" H/P Tube	30,000 PSI 2070 bar	0.15	3.31" (84.1)	2.50" (63.5)	1.12" (28.4)	0.88" (22.4)
60SC6-SOG	3/8" H/P Tube	30,000 PSI 2070 bar	0.28	3.75" (95.3)	3.00" (76.2)	1.38" (35.1)	1.12" (28.4)
60SC9-SOG	9/16" H/P Tube	30,000 PSI 2070 bar	0.63	4.57" (116.1)	3.38" (85.9)	1.50" (38.1)	1.38" (35.1)

To order a valve with a cracking pressure other than the standard 15 PSI, add the cracking pressure to the end of the catalog number. Example: A 60SC4-SOG with 40 PSI cracking pressure would be ordered as **60SC4-SOG-40**.

Cracking pressures available up to 100 PSI (7 bar)

SOUR GAS FILTERS

BuTech line filters are used in system lines to remove contaminating particles from the system fluid. Upstream filter of larger micron rating than downstream filter to prevent clogging of downstream filter.

Standard materials of construction are 316 stainless steel with 300 series stainless steel filter discs. Available in nominal ratings of: 0.5, 2, 5, 10, 20, 40, and 100 micron.

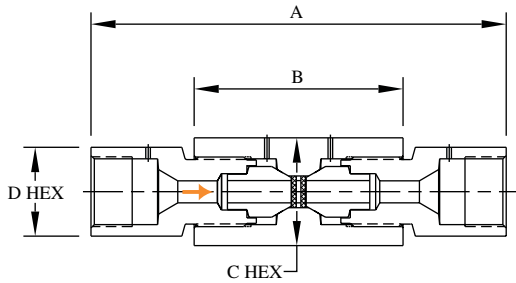

LINE FILTERS

Catalog Number	Connection	MAWP	Area*	A	B	C	D
60LF4-SOG	1/4" H/P Tube	30,000 PSI 2070 bar	0.15 in ² 97 mm ²	4.06" (103.1)	2.62" (66.5)	1.38" (35.1)	0.88" (22.4)
60LF6-SOG	3/8" H/P Tube	30,000 PSI 2070 bar	0.15 in ² 97 mm ²	4.56" (115.8)	2.62" (66.5)	1.38" (35.1)	1.00" (25.4)
60LF9-SOG	9/16" H/P Tube	30,000 PSI 2070 bar	0.15 in ² 97 mm ²	6.00" (152.4)	3.62" (91.9)	1.50" (38.1)	1.38" (35.1)

*Effective area of filter element

Micron rating of filter must be specified. To order, complete the catalog number with the desired micron rating, upstream first:

60LF4-SOG-40/20

specifies a line filter with 1/4" H/P connections, a 40 micron filter upstream and 20 micron downstream.

BuTech sintered cup filters offer maximum filtration surface area for removal of contaminating particles from the fluid system. They may be used in systems which require high flow rates with minimum pressure drop.

Standard materials of construction are 316 stainless steel with 300 series stainless steel filter discs. Available in nominal ratings of: 5, 10, 20, 40, and 100 micron.

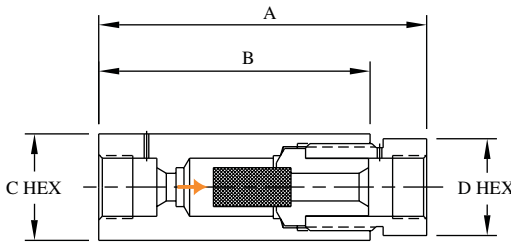

SINTERED CUP FILTERS

Catalog Number	Connection	MAWP	Area*	A	B	C	D
60SCF4-SOG	1/4" H/P Tube	30,000 PSI 2070 bar	0.44 in ² 284 mm ²	3.32" (84.3)	2.50" (63.5)	1.12" (28.4)	0.88" (22.4)
60SCF6-SOG	3/8" H/P Tube	30,000 PSI 2070 bar	0.54 in ² 348 mm ²	3.75" (95.3)	3.00" (76.2)	1.38" (35.1)	1.12" (28.4)
60SCF9-SOG	9/16" H/P Tube	30,000 PSI 2070 bar	0.86 in ² 555 mm ²	4.70" (119.4)	3.37" (85.6)	1.50" (38.1)	1.38" (35.1)

*Effective area of filter element

Micron rating of filter must be specified. To order, complete the catalog number with the desired micron rating:

60SCF4-SOG-20

specifies a line filter with 1/4" H/P connections and a 20 micron filter.

All dimensions are for reference only and are subject to change.
Dimensions in parentheses are millimeters (mm)

SOUR GAS SAFETY HEADS & RUPTURE DISCS

BuTech safety head assemblies serve as holders for standard rupture discs (sold separately). Safety heads with rupture discs are used as simple and inexpensive overpressure relief devices. System pressure is relieved as a result of rupture of the replaceable disc.

The safety head assemblies shown are designed for use in high pressure systems up to 20,000 PSI (1380 bar). They can be installed directly into any of our standard couplings, elbows, tees, or crosses. Their versatility also allows direct installation into a standard 3-way valve. The result is a combination valve/safety head with beneficial cost and space advantages.

Standard material of construction is 316 stainless steel.

Safety head assemblies and rupture discs are available in two styles:

The **1/4A** style features a 1/4" blow-out diameter, an angular seat and can be ordered in pressures from 900 to 60,000 PSI (62 to 4140 bar)

The **1/2F** style features a 1/2" blow-out diameter, a flat seat and can be ordered in pressures from 500 to 10,000 PSI (34 to 689 bar). This style also has a reversible hold-down ring which greatly reduces the possibility of premature disc failure associated with installation errors inherent in some designs.

Rupture discs are available in a wide range of burst ratings. Factors such as corrosion, fatigue and temperature may affect the burst pressure of the disc and cause premature failure. This problem may sometimes be overcome by frequent replacement of the disc. All discs rated over 500 PSI (34 bar) have a manufacturing tolerance of 3% under to 6% over the specified rupture pressure rating.

Rupture Discs are not included in the safety head assembly. To order discs separately, contact local distributor.

SAFETY HEADS - 1/4" ANGLED DISC

Catalog Number	Connection	MAWP	A	B	C	Discharge
60SH4-1/4A-SOG	1/4" H/P Tube	30,000 PSI 2070 bar	1.00" (25.4)	2.75" (69.9)	1.00" (25.4)	3/8" FNPT
60SH6-1/4A-SOG	3/8" H/P Tube	30,000 PSI 2070 bar	1.00" (25.4)	2.81" (71.4)	1.00" (25.4)	3/8" FNPT
60SH9-1/4A-SOG	9/16" H/P Tube	30,000 PSI 2070 bar	1.38" (35.1)	2.88" (73.0)	1.00" (25.4)	3/8" FNPT

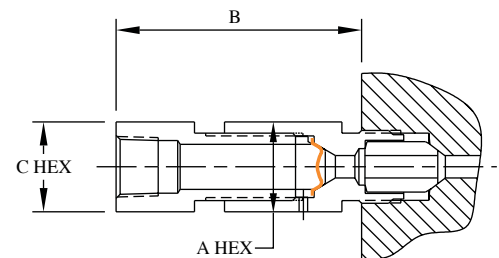

SAFETY HEADS - 1/2" FLAT DISC

Catalog Number	Connection	MAWP	A	B	C	Discharge
60SH4-1/2F-SOG	1/4" H/P Tube	10,000 PSI 689 bar	1.00" (25.4)	2.68" (68.1)	1.00" (25.4)	3/8" FNPT
60SH6-1/2F-SOG	3/8" H/P Tube	10,000 PSI 689 bar	1.00" (25.4)	2.81" (71.4)	1.00" (25.4)	3/8" FNPT
60SH9-1/2F-SOG	9/16" H/P Tube	10,000 PSI 689 bar	1.38" (35.1)	2.81" (71.4)	1.00" (25.4)	3/8" FNPT

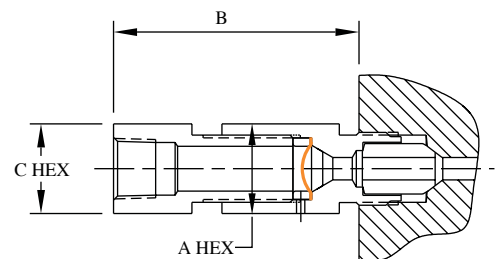

All dimensions are for reference only and are subject to change.
Dimensions in parentheses are millimeters (mm)

Tested to 14,000 feet (over 4200 meters)

As a supplier of equipment to the petroleum industry for over twenty years, BuTech offers an extensive line of check valves, needle valves, 2-, 3-, 4- & 5-way ball valves with 3/16" to 1" ports, as well as fittings, tubing and related equipment for petroleum production.



Our Sub-Sea Valves are custom designed for instrumentation, process control and chemical injection applications in the harshest environments. Designed for Remote Operated Vehicle (ROV) operation, these valves provide rugged protection, safety and reliability in template control panels, sub-sea wellheads and christmas trees.

Manufactured to meet the requirements of NACE MR0175 / ISO 15156, API Spec. 6A and 17D, and numerous other specifications, BuTech Sub-Sea Valves ensure trouble-free operation in hydrogen sulfides, corrosion inhibitors, paraffin thinners, hydraulic fluids and many other chemicals.

Please call the BuTech sales staff for custom design of a valve to meet your needs.

